

 moldurarte®

As melhores molduras

 **Moldurarte**[®]
As melhores molduras

A Moldurarte

Desde sua fundação em 1961, a marca MOLDURARTE se consolida cada vez mais como sinônimo de qualidade, sendo considerada uma das maiores empresas produtoras mundiais de molduras de madeira, graças ao trabalho qualificado e atualizado de seus mais de 400 colaboradores e ao seu moderno complexo industrial com mais de 45.000 m2 de área construída, com capacidade produtiva de 16 milhões de metros lineares/ano, garantindo assim o melhor e o mais completo mix de produtos e o maior estoque de molduras do mercado mundial.

Moldurarte

Since its establishment in 1961, the MOLDURARTE brand is more closely identified with quality and is considered one of the biggest wooden picture frame moulding manufacturers in the world. This is due to the fine quality performance of over 400 collaborators and the modern industrial complex. The complex has over 45.000 m2 of constructed area with a production capacity of 16 million linear meters (52.49 million feet) per year. Moldurarte has established a perfect fusion between man and machine, to offer our clients the best and most complete product mix from the largest mouldings stock in the world.

Moldurarte

Desde su fundación, en 1961, la marca MOLDURARTE se consolida cada vez más como sinónimo de calidad, siendo considerada una de las mayores productoras mundiales de molduras de madera para marcos y portarretratos. Gracias al trabajo de calidad y la constante capacitación de sus más de 400 colaboradores, a su moderno complejo industrial con más de 45.000 m2 de área construida que nos permite tener una capacidad productiva de 16 millones de metros lineares por año, hacen una fusión perfecta entre hombre y máquina para ofrecer a los clientes el mejor y más completo mix de productos y poder mantener el mayor stock de molduras del mercado mundial.



Acesse o QR Code para assistir nosso vídeo institucional

Scan the QR Code to watch our institutional video.

Lea el QR Code para ver nuestro video institucional.



Centro administrativo | Estoque | Expedição Braço do Norte -SC

*Administrative Center / Storage Area / Shipping Area - Braço do Norte - SC
Centro administrativo / Stock / Área de Embarque - Braço do Norte - SC*



Unidade de Usinagem São Ludgero - SC

*Wood Preparation - São Ludgero - SC
Unidad de Preparación de la Madera - São Ludgero - SC*



Unidade de Produção Braço do Norte - SC

*Production Sector - Braço do Norte - SC
Unidad de Producción - Braço do Norte - SC*



A preocupação da Moldurarte com o meio ambiente é constante

Nossas 6 fazendas de cultivo de madeira, juntas totalizam 3.982 hectares, onde são cultivadas mais de 2.500.000 árvores das espécies Pinus e Eucalipto, garantindo a origem da nossa principal matéria prima: MADEIRA.

Tudo o que a MOLDURARTE produz tem como base o desenvolvimento sustentável. Em nossas unidades todos os efluentes líquidos são tratados através de duas estações de tratamento, reduzindo ao máximo a emissão de poluentes e garantindo a biodiversidade e o equilíbrio dos ecossistemas das regiões onde atuamos.

Tudo isso confirma nossa responsabilidade socioambiental.

Fazenda de Cultivo de Madeira Bom Retiro – SC

Wood Reforestation Farm – Bom Retiro – SC
Hacienda de Reforestación de Madera – Bom Retiro – SC

Moldurarte's concern for the environment is continuous

Our 6 farms with a total of 3.982 hectares where over 2,500,000 Pine and Eucalyptus trees are planted; this guarantees the origin of our main raw material: WOOD.

Everything produced by MOLDURARTE has as its base - sustainable development and also. All liquid effluents are treated in two treatment stations, reducing the maximum level of emissions pollutants; this guarantees the biodiversity and balance of the ecosystems of the regions that we manage.

All this added to social and environmental responsibility, prove our attitude towards the community and the environment.

La preocupación y respeto de Moldurarte con el medio ambiente es constante

Contamos con 6 propiedades totalizando 3982 Hectáreas, donde mantenemos plantaciones y reforestación de árboles de Pino y Eucalipto, mantenemos más de 2.500.000 de plantines, garantizando así el origen de nuestra principal materia prima, MADERA.

Todo que MOLDURARTE produce tiene como base el desenvolvimiento sustentable. Todos los efluentes líquidos de nuestros procesos de producción son tratados a través de dos estaciones propias de tratamiento, reduciendo al máximo la emisión de poluyentes y garantizando la biodiversidad y el equilibrio de los ecosistemas de las regiones donde actuamos.

Todo esto sumado a la responsabilidad social demuestra nuestra postura frente a la comunidad y para con el medio ambiente.

Nossas molduras estão agrupadas por acabamentos e produtos

Our mouldings are grouped by finishes and product types

Las nuestras molduras están agrupados por acabados y tipos de productos

	Páginas Page / página
Dourado / Gold/ Dorado	06 - 27
Prata / Silver / Plateado	28 - 45
Metalizado / Metallic / Metálico	46 - 57
Laminado / Laminated / Laminado	58 - 63
Amadeirado / Woody / Amaderado	64 - 73
Rústico / Rustic / Rústico	74 - 79
Provençal / Provence / Provenzal	80 - 83
Colorido / Colored / Colorido	84 - 91
Preto / Black / Negro	92 - 101
Branco / White / Blanco	102 - 111
Filetes e Passepartout / Fillet and Passepartout / Filete y Passepartout	112 - 117
Canaletas e Complementos de Telas / Floater / Molduras para Enmarcar Telas	118 - 121
Chassis / Stretcher Bar / Bastidor	122 - 123

No final do catálogo encontra-se o índice por código da moldura e informação dos perfis por agrupamento de acabamentos

At the end of the catalog is the code index of each moulding and the information of the profiles grouped by type of finishes

Al final del catálogo se encuentra el índice por código de cada moldura y información de los perfiles agrupados por acabados



FOLHEADA PRATA
SILVER LEAF
HOJA PLATA



FOLHEADA OURO
GOLD LEAF
HOJA ORO



ALTO BRILHO
HIGH SHINE
DE ALTO BRILLO



PINUS SEM NÓ
E SEM EMENDA
WOOD PINE WITHOUT FINGER
JOINTS NOR KNOTS FROM PINE
MADEIRA PINO SIN LOS FINGER
JOINTS Y NI LOS NUDOS DEL PINO



MADEIRA DO NORTE
NATIVE LUMBER
ENCHAPADO NATIVA



RECOBRIMENTO PET
WRAPPING PET
(POLYETHYLENE TEREPHTHALATE)
RECUBRIMIENTO
MATERIAL PET

As cores das molduras podem sofrer variação devido a impressão e ao tipo de papel. A numeração da milimetragem dos perfis respeitaram as dimensões reais, porém os tamanhos, tanto as imagens como dos desenhos técnicos das molduras, aplicados neste catálogo, correspondem a aproximadamente 60% do tamanho real dos produtos

Colours of the mouldings can suffer variations due to the printing quality and paper type. The millimetric numbering of the profiles will respect their real dimensions, however, the size of the images as well as the technical drawings of the mouldings from this catalog are corresponding approximately to 60% of the real size of the final products

Los colores de las molduras pueden sufrir variaciones debido a la impresión y el tipo de papel. La numeración milimétrica de los perfiles respetarán las dimensiones reales, sin embargo los tamaños, tanto de las imágenes como de los diseños técnicos de las molduras aplicados en este catálogo, corresponden aproximadamente a un 60% del tamaño real de los productos finales



Dourado

Gold / Dorado



Rei Luiz - 8669

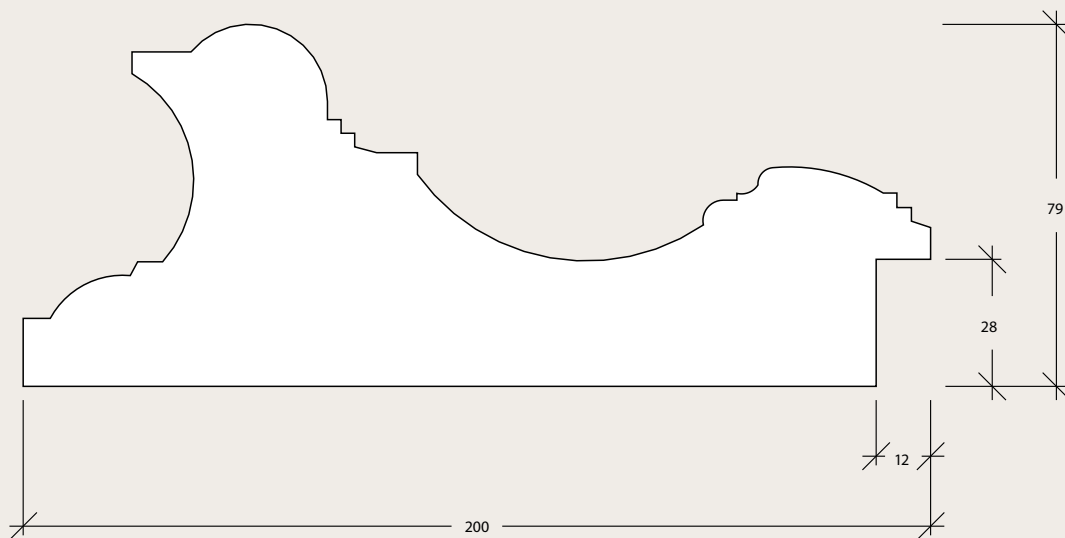

Rei Luiz



Volúpia



2046-8497

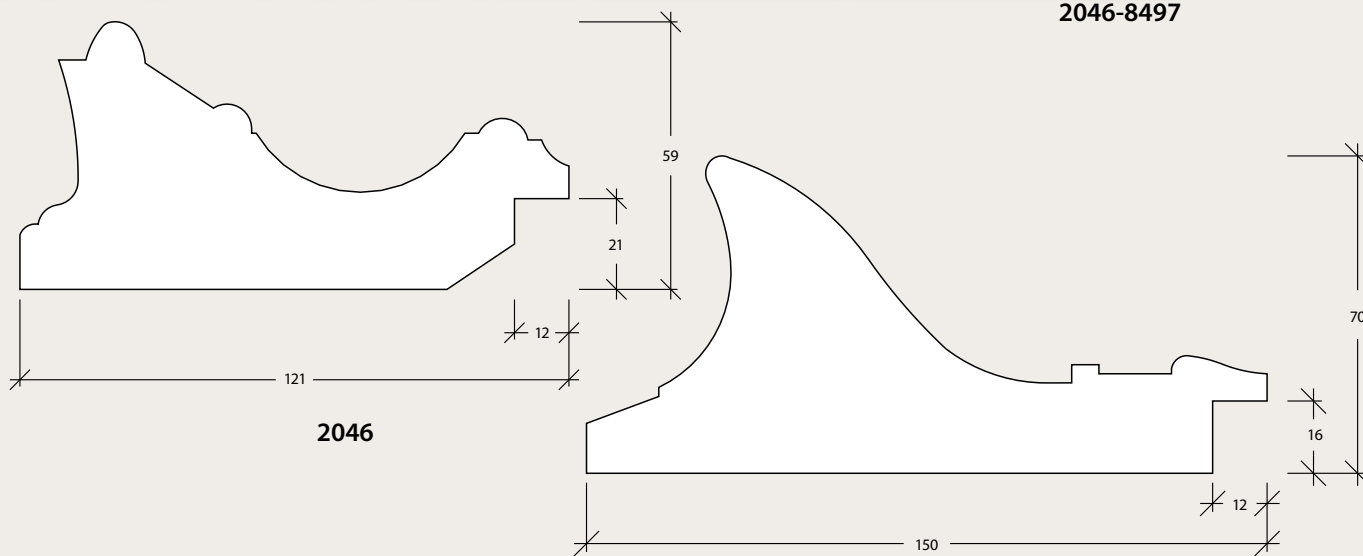

Volúpia



2072-9160



2072-9161

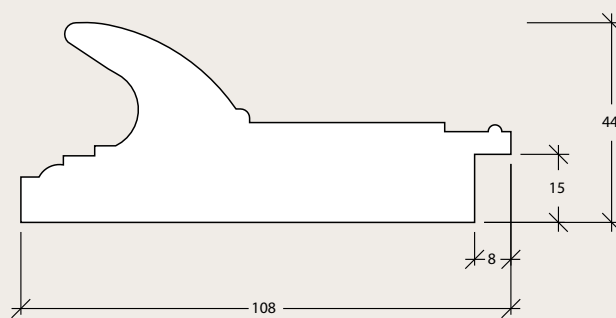

2072



270N-237



2044-8427

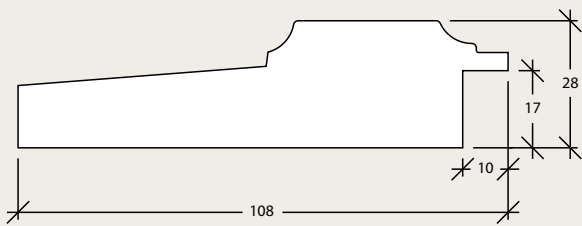

270N

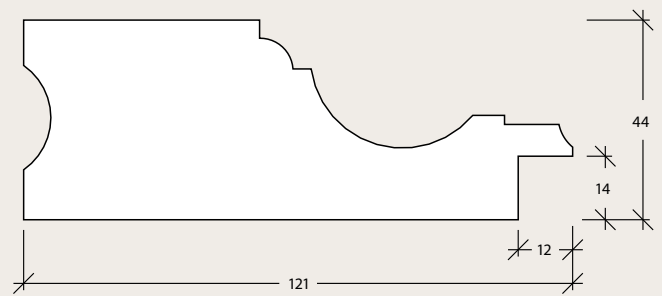

2044



350-10



350-8931



SL-93N-278

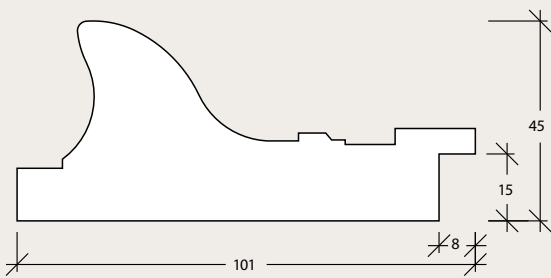

350

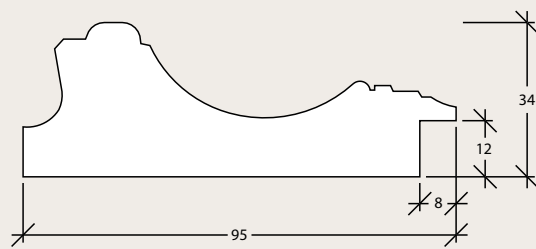

SL-93N



3060-9072



2037-8366



2055-8589

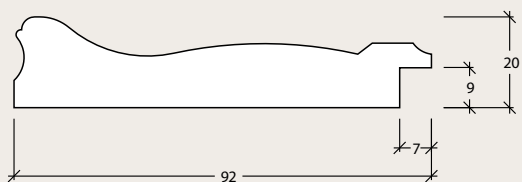

3060

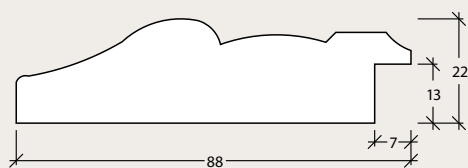

2037

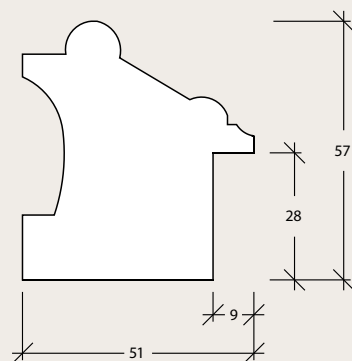

2055



2059-8663



G7S



G7S-9138



G7S-9137

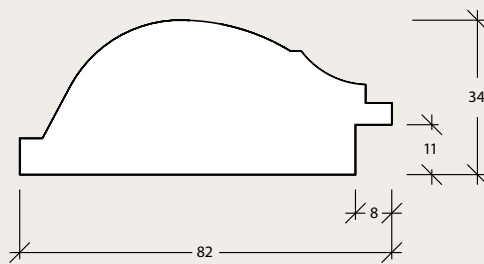

2059

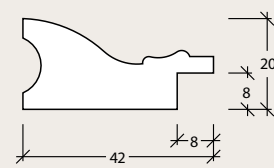

G7S



3073-9119



3028-8438



3055-8995



3069-9108

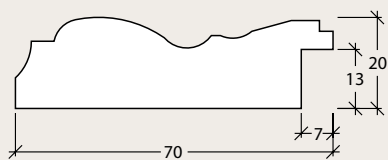

3073

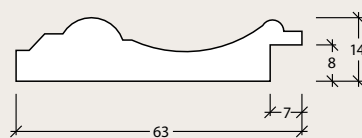

3028

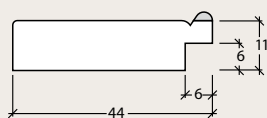

3055

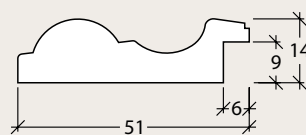

3069



2035-8364



2035-8931



2063-8410



329-9172



329-52



3075-9135

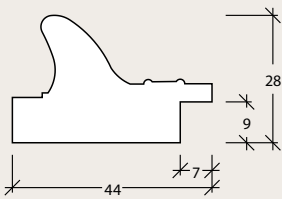

2035

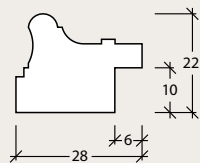

2063

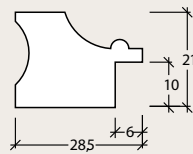

329

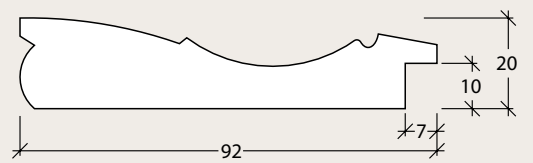

3075



Gold 9



354-12

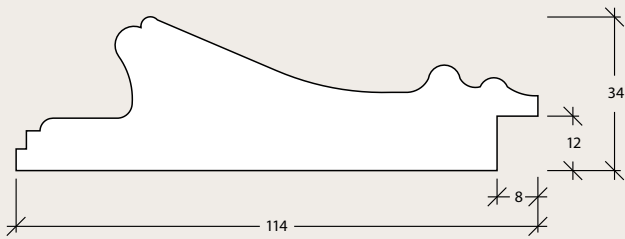

Gold 9

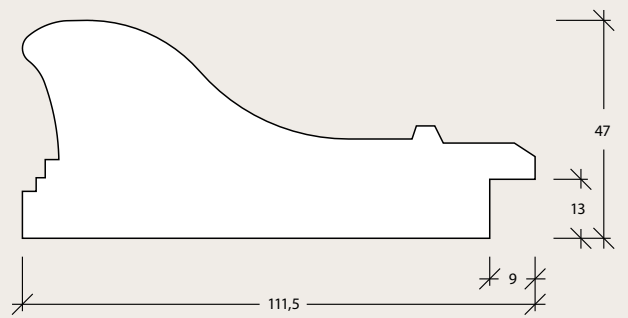

354

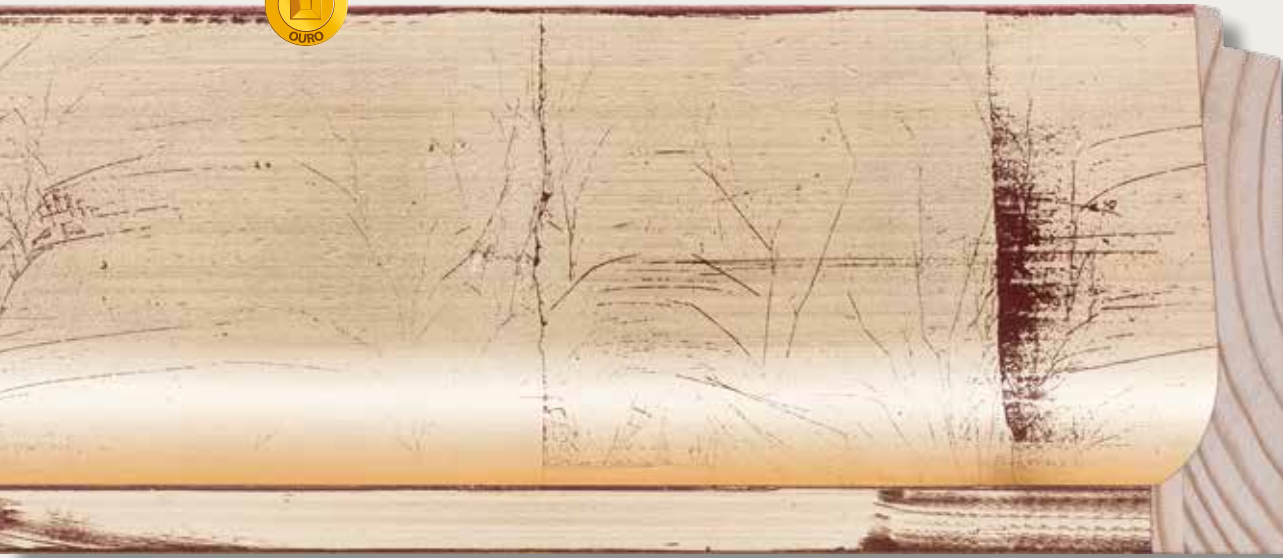

2066-9003



5067-9152

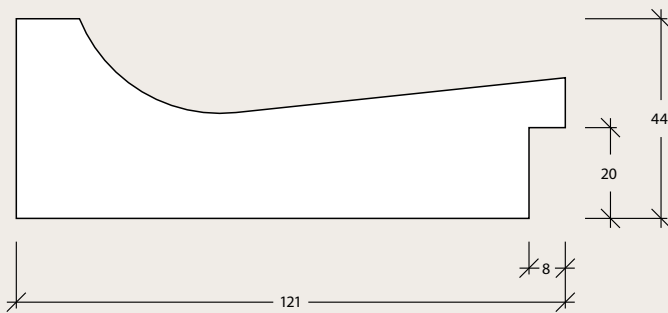

2066

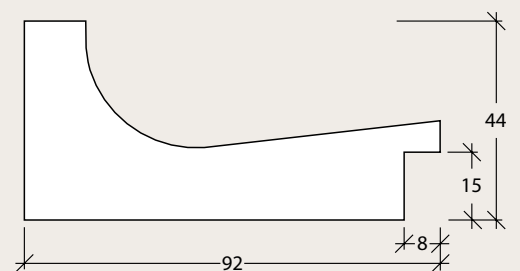

5067



180-G59G



381-GR420



380-R59



380-9175

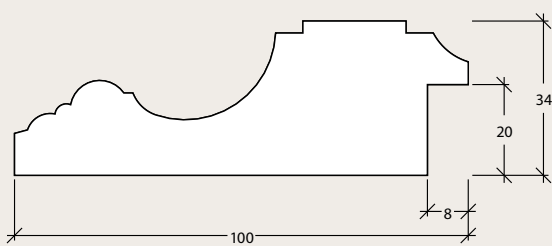

180

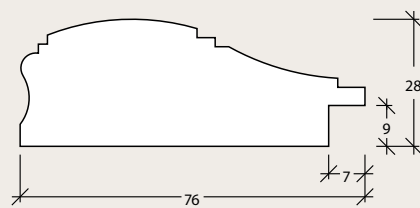

381



3033-8535



3033-8536



3036-8542



3036-9179



4021-8344

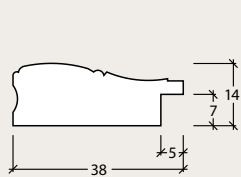

380

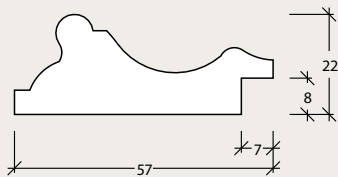

3033

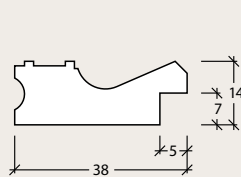

3036

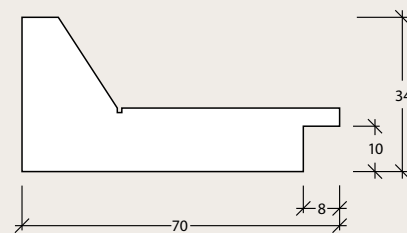

4021



2233-1548



2266N-1548



3027-8412

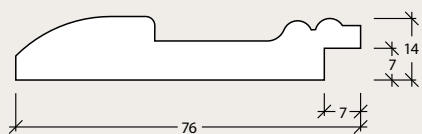

3027

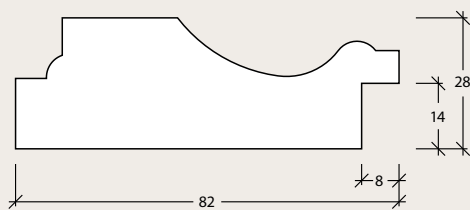

2233

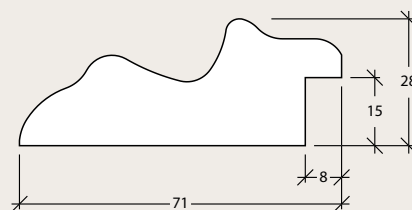

2266N



3034-8539



3034-8538



3023-8307



2151-1548

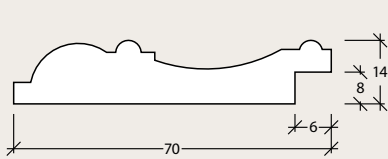

3034

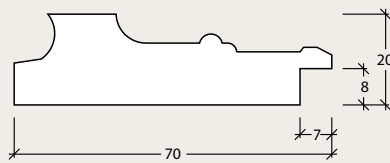

3023

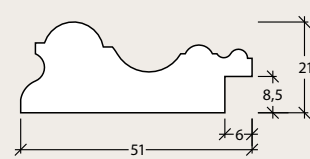

2151



5033-8479



149-500



1034-47



720-47

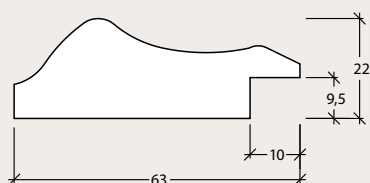

1034

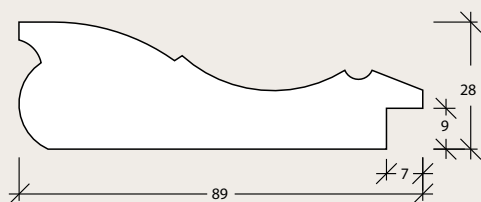

5033

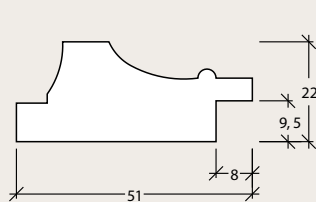

720

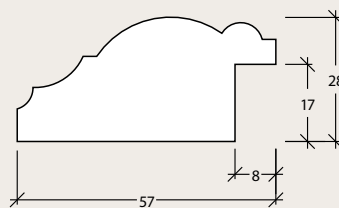

149

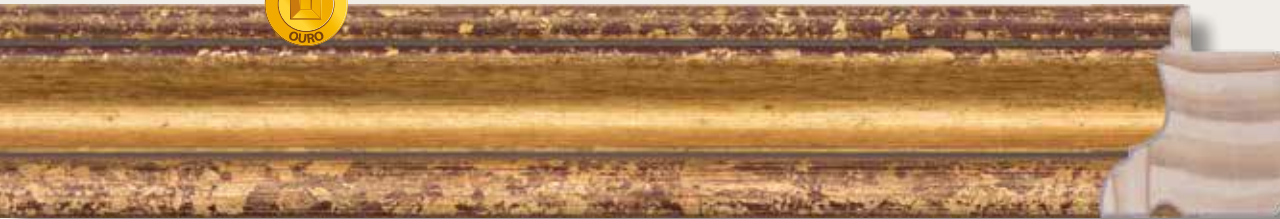

SL-22-205



2043-8410



SL-02-106



SL-02-9165



2016-9163



2016-301

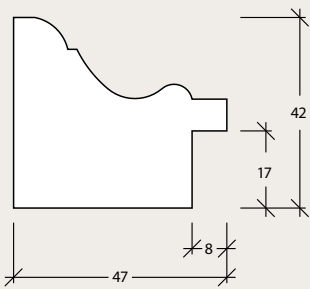

SL-22

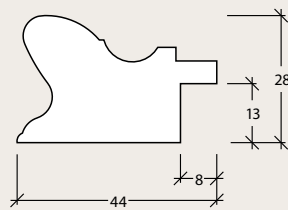

2043

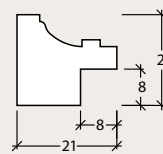

SL-02

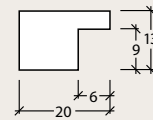

2016



1510-8979



1210-5159



SL-07-108



5061N-9083



5048-8927



122-5159

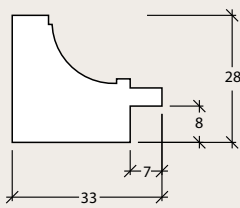

5061N

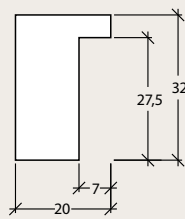

1210

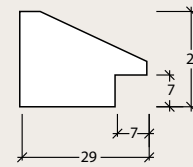

122

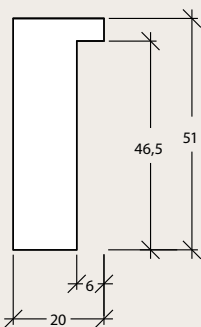

1510

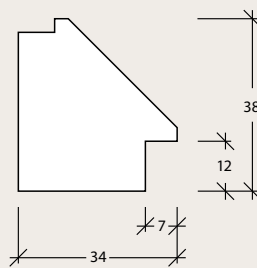

5048

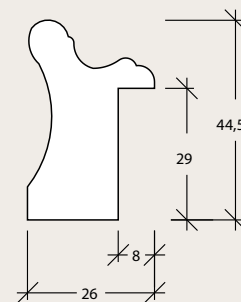

SL-07



KD-303-17



1448-35



KD-302-41



227-236



3002-31

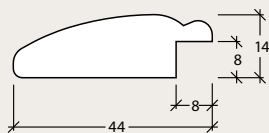

KD-303

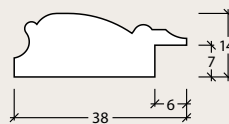

1448

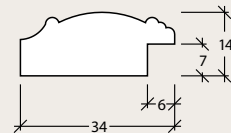

KD-302

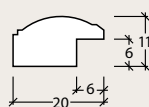

227

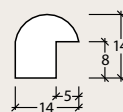

3002



5105-1978



6034-5159



2016-59



81-HS-59



81-9152

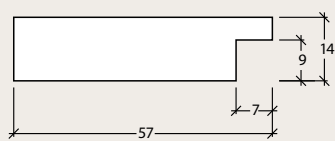

5105

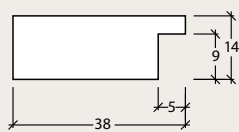

6034

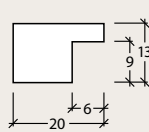

2016

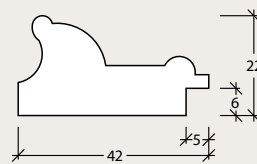

81



5045-8670



6059N-8259



2016-8470



78-ONS



5044-8639



5044-8637

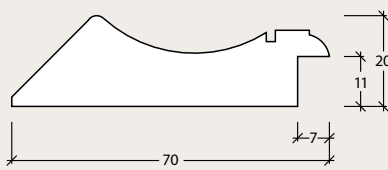

5045

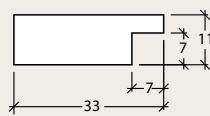

6059N

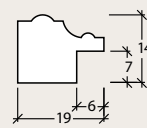

78

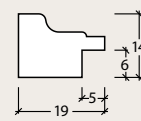

5044



Prata

Silver / Plateado



Rei Luiz - 8668

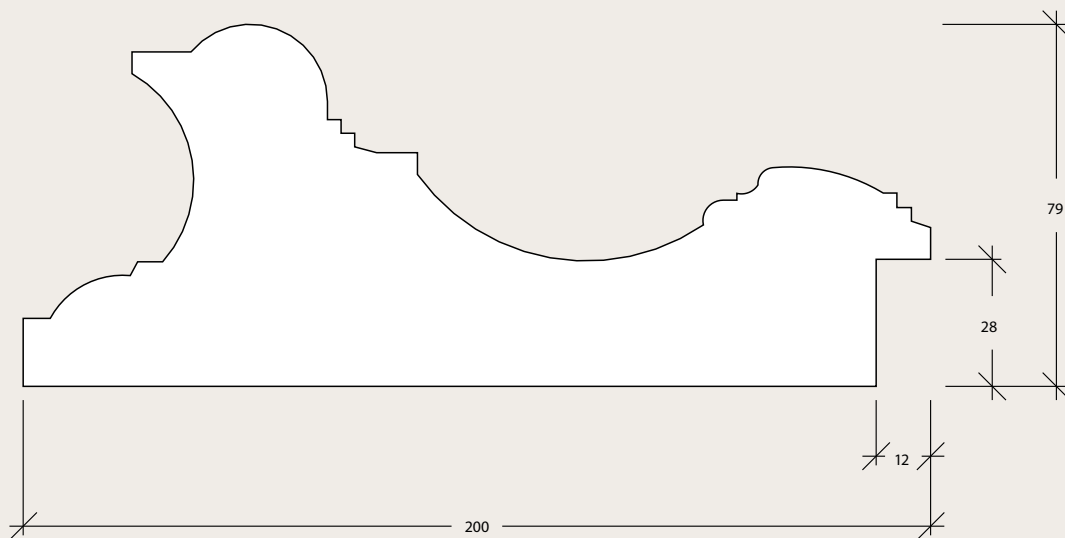

Rei Luiz



2044-8428



Gold 7

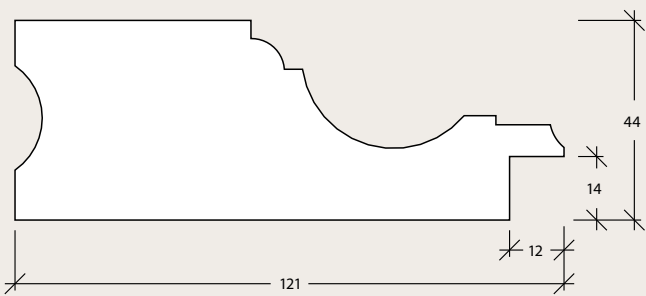

2044

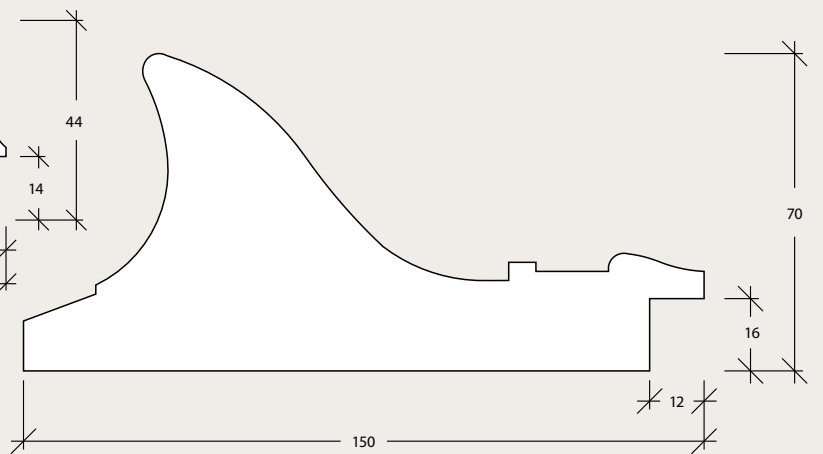

Gold 7



2072-9162



2037-8367

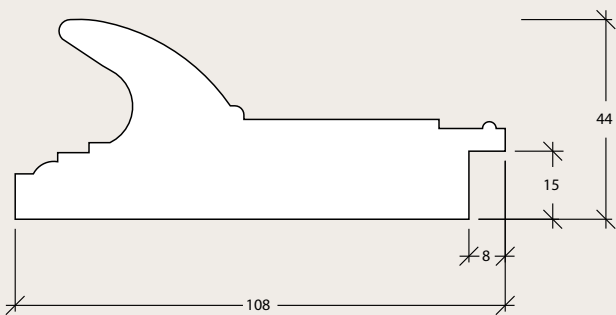

2072

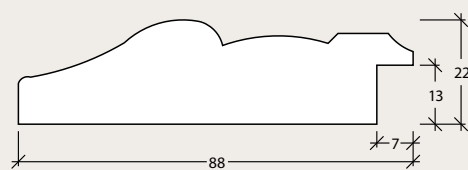

2037



350-8932



2035-8363



2035-8932



2063-8409

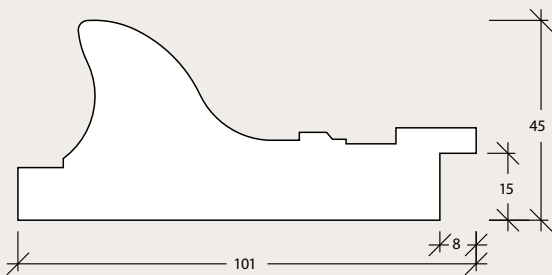

350

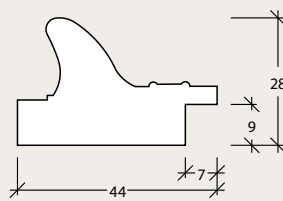

2035

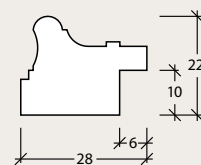

2063



3060-9073



2059-8664



2055-8590

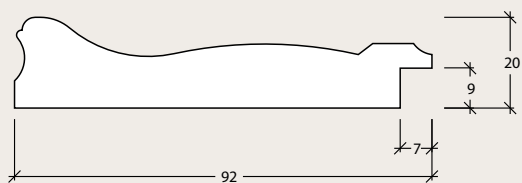

3060

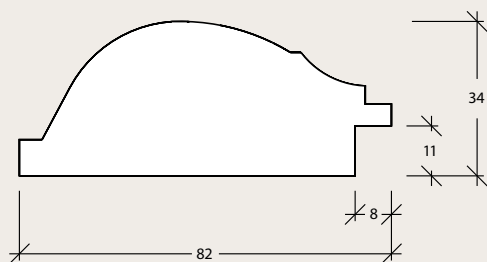

2059

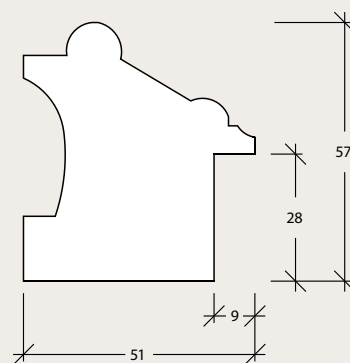

2055



3073-9120



3069-9109



3069-9107



G75-9139

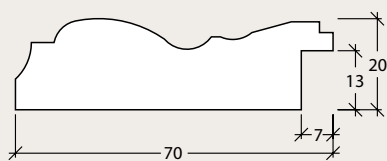

3073

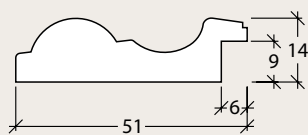

3069

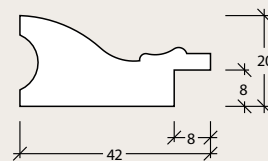

G75



380-9176



329-9173



3055-8996



3036-9181



5061N-9082



380

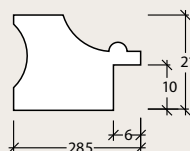

329

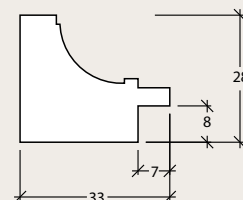

5061N

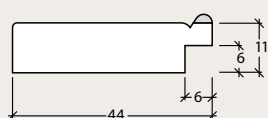

3055

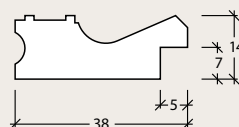

3036



Gold 8

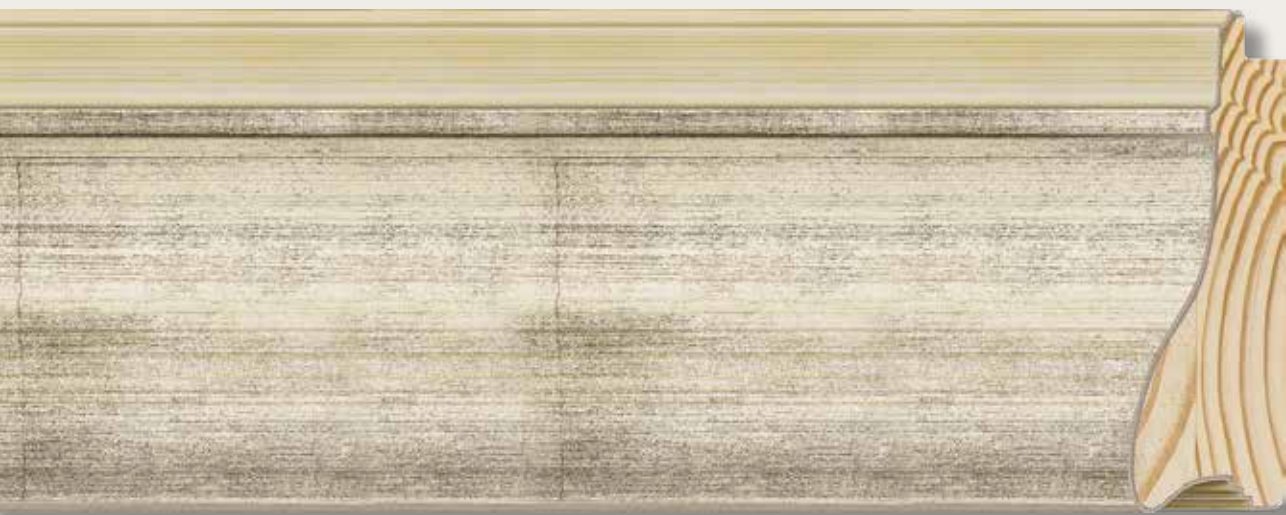

354-13

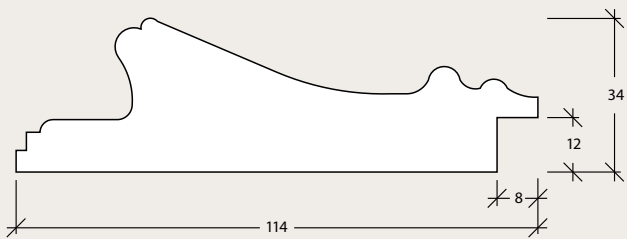

Gold 8

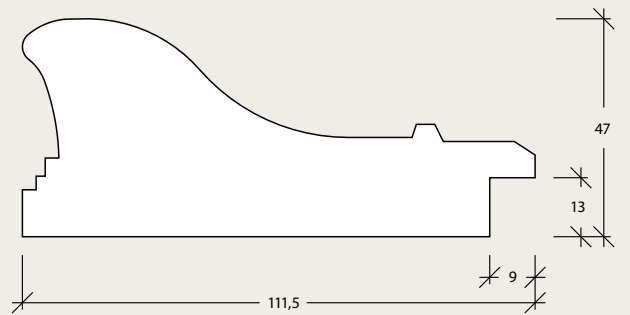

354

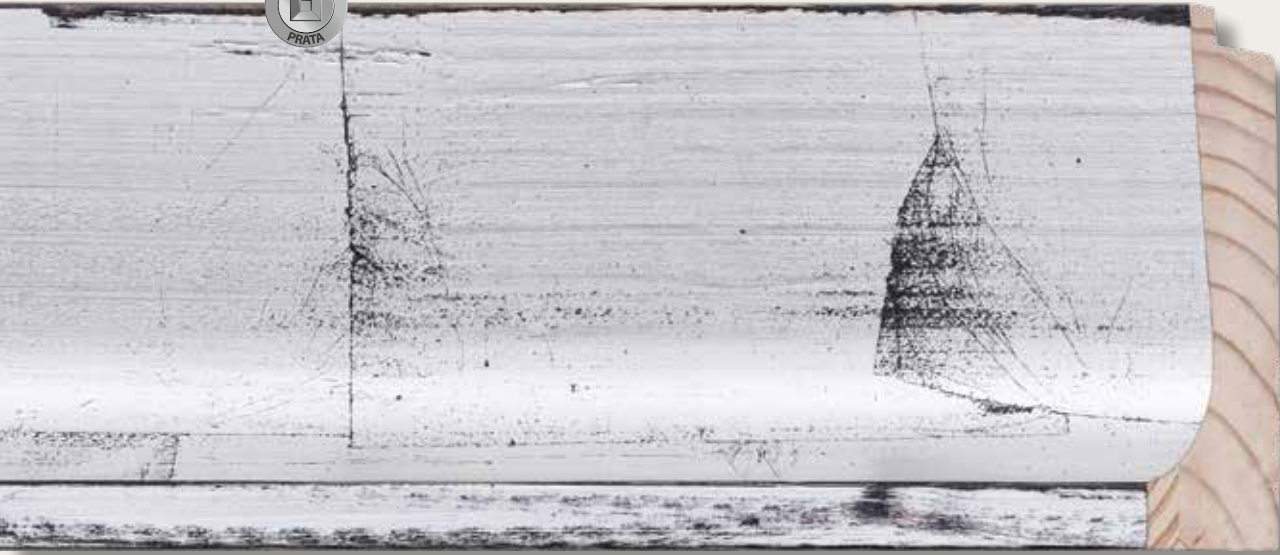

2066-9004



5067-9153

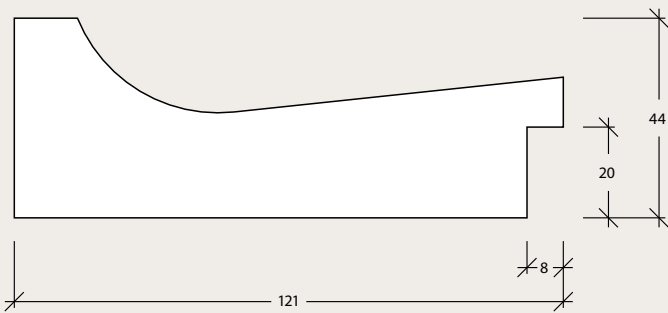

2066

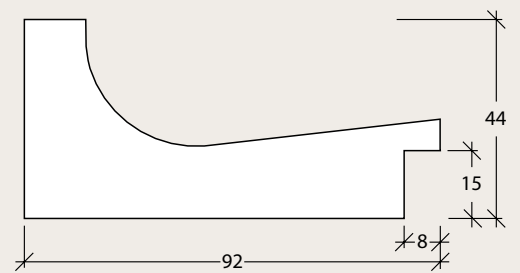

5067



3075-9136



5045-8671



309-47

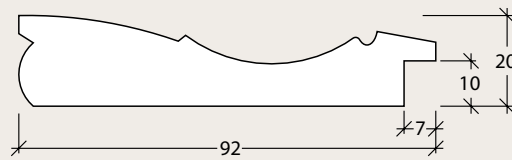

3075

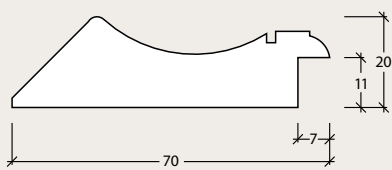

5045

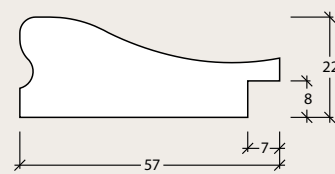

309



2043-8409



SL-22-148



81-215



2042-8407



2042-8408

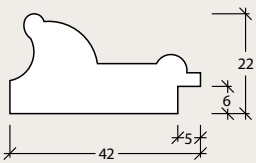

81

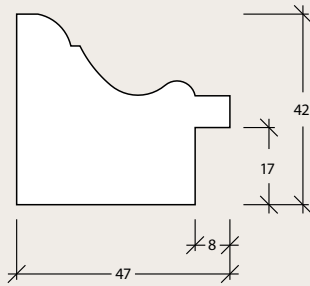

SL-22

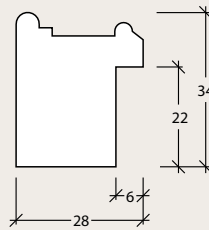

2042

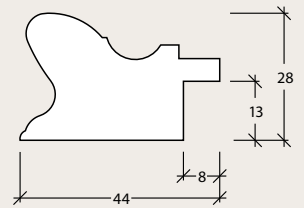

2043



4033-8434



4033-8436



1510-HS-65



1210-1979



1210-8401



1210-8547



1210-HS-65

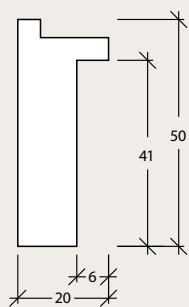

4033

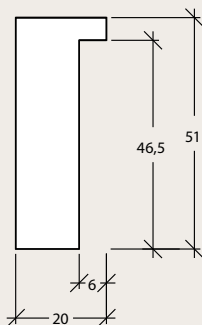

1510

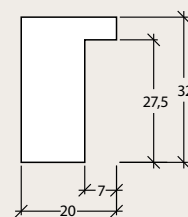

1210



4021-8346



5058-9057



4054-8595



5039-8628

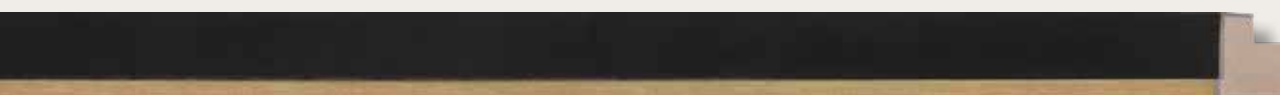

5039-9013

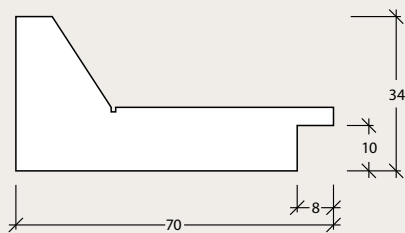

4021

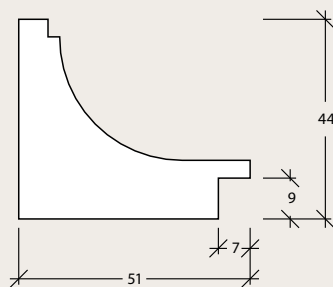

5058

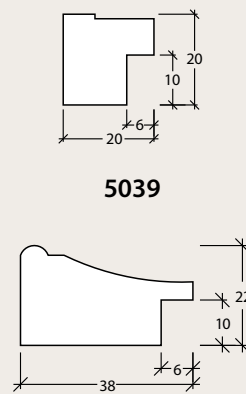

4054



117-38547



5066-13



5105-1979

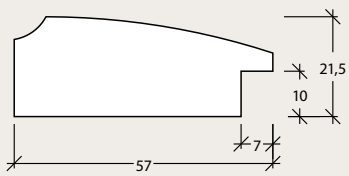

117

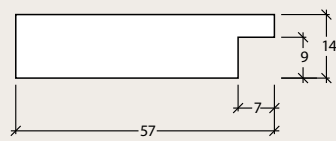

5105

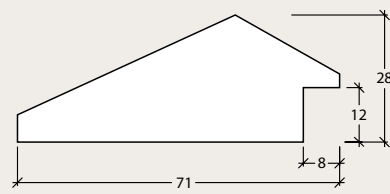

5066



9009-HS-65



9N-HS-65



2016-HS-65



6034-8547

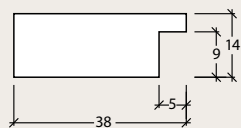

6034

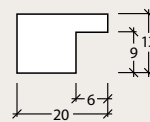

2016

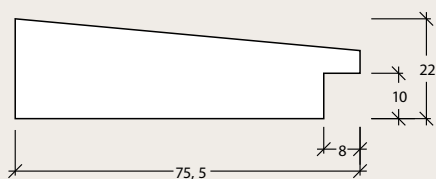

9009

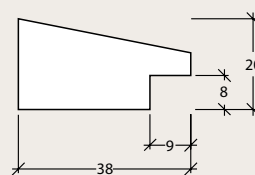

9N



KD-303-18



KD-302-40



3034-8537



3033-8534

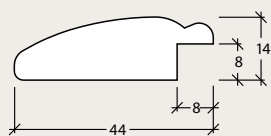

KD-303

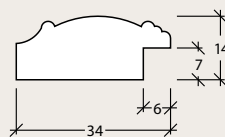

KD-302

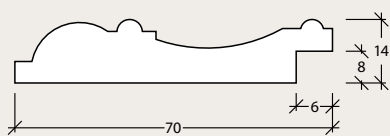

3034

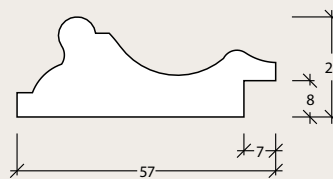

3033



2016-302



5044-8638



2016-8469



78-9066



2016-47



2016-9164



SL-02-9166



SL-02-148



SL-07-148

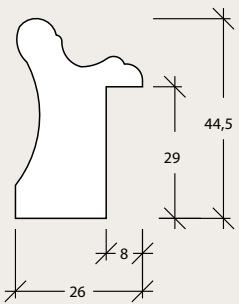

SL-07

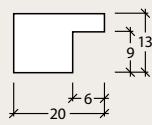

2016

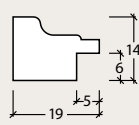

5044

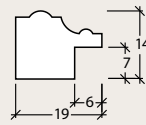

78

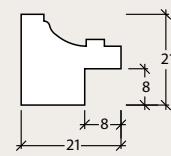

SL-02

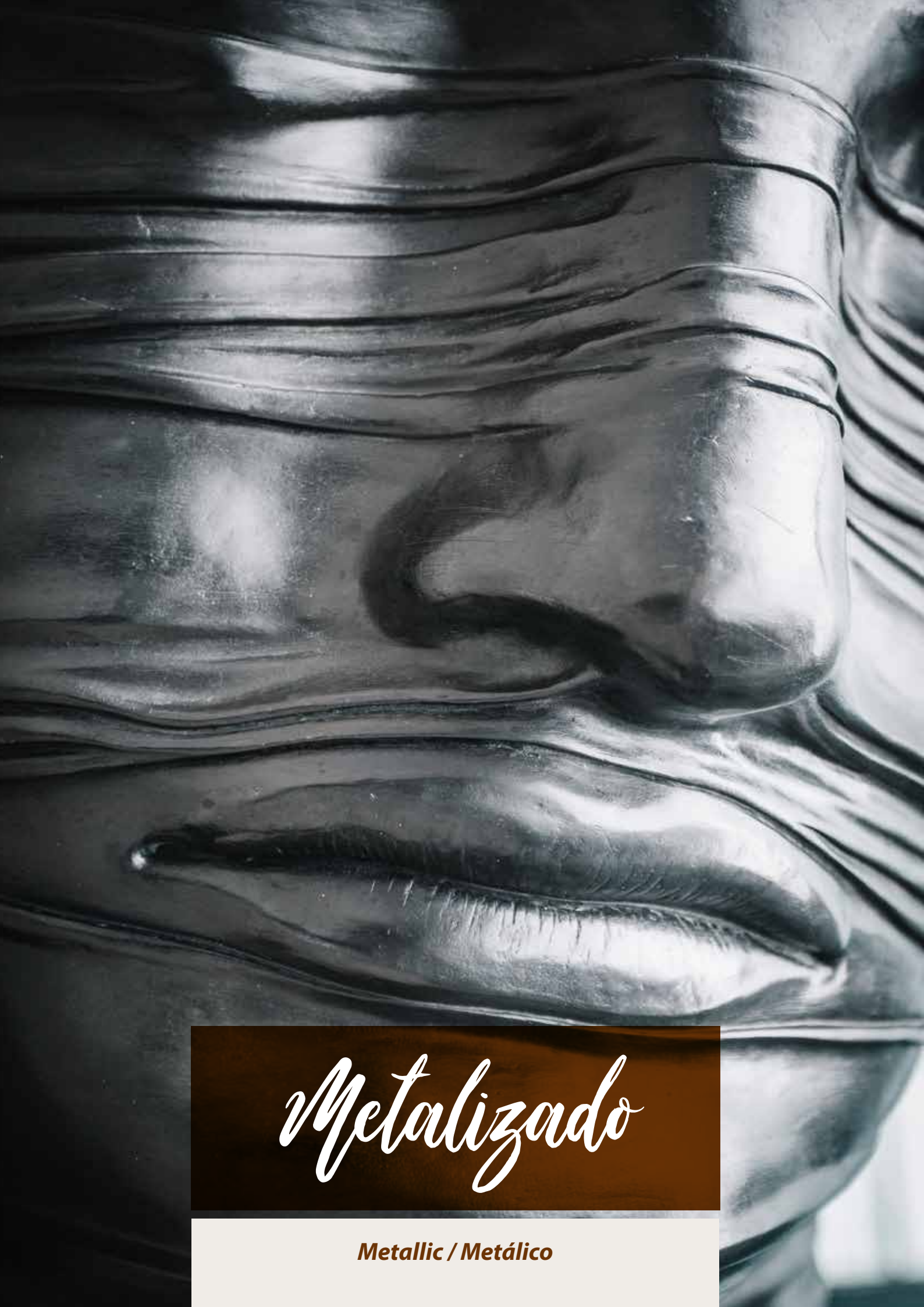

Metallizado

Metallic / Metálico

5065-9144

4058-9144

6034-9144

98-9144

10-9144

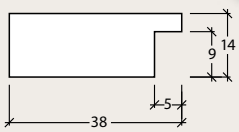

6034

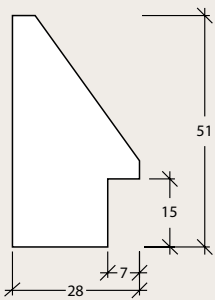

5065

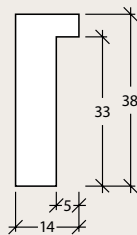

4058

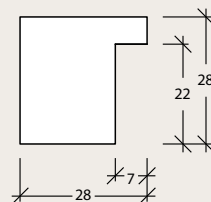

98

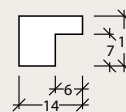

10

5065-9142

4058-9142

6034-9142

98-9142

10-9142

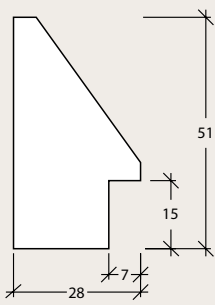

5065

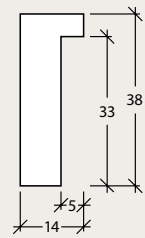

4058

5065-9146

4058-9146

6034-9146

98-9146

10-9146

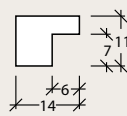

10

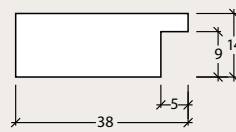

6034

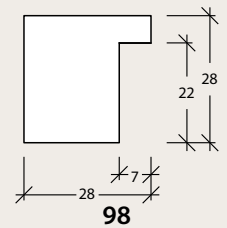

98



998-9170



1210-9170



4015-8184



122-8184

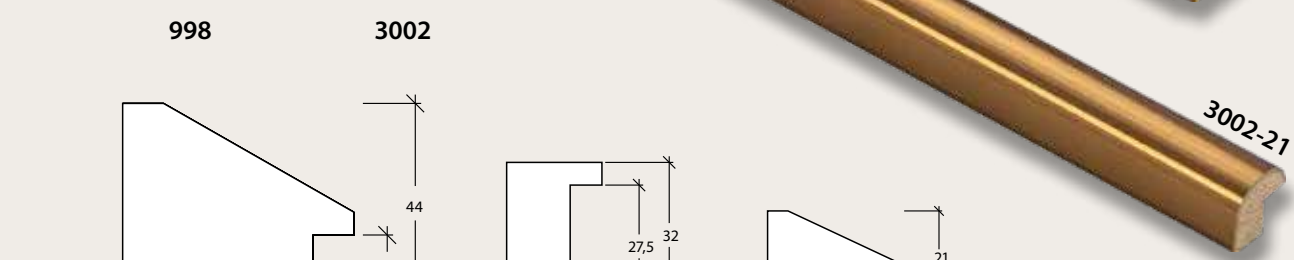

3002-21

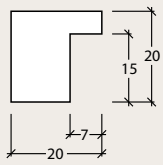

998

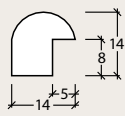

3002

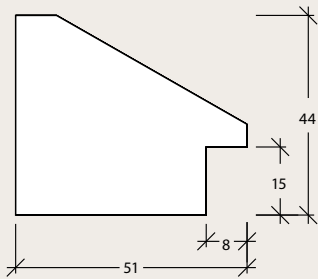

4015

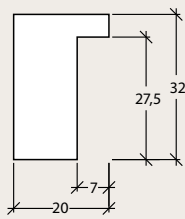

1210

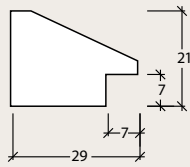

122

SL-36-9054

5032-8476

9N-9054

5066-9054

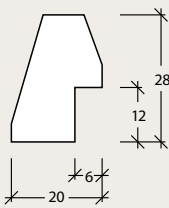

5032

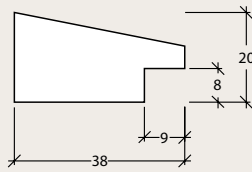

9N

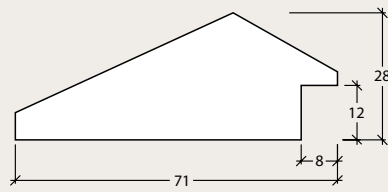

5066

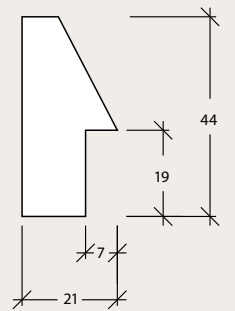

SL-36

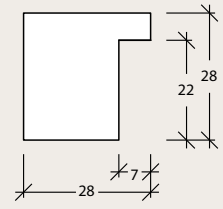

98

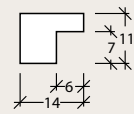

10

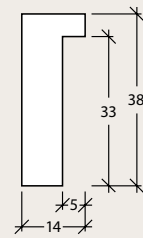

4058

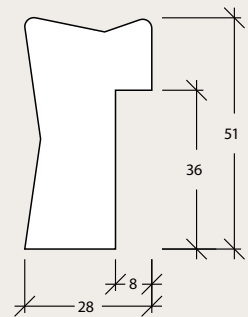

4030

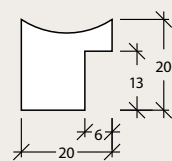

5050

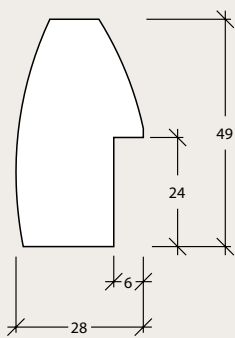

SL-21

SL-21-144

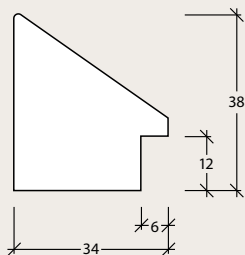

5054

5054-9013

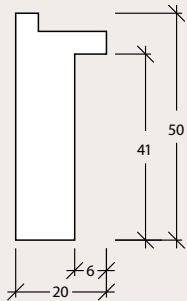

4033

4033-8435

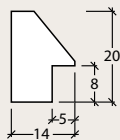

5064

5064-8425

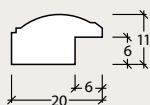

227

227-8531





SL-58-194



SL-12-126



SL-36-126

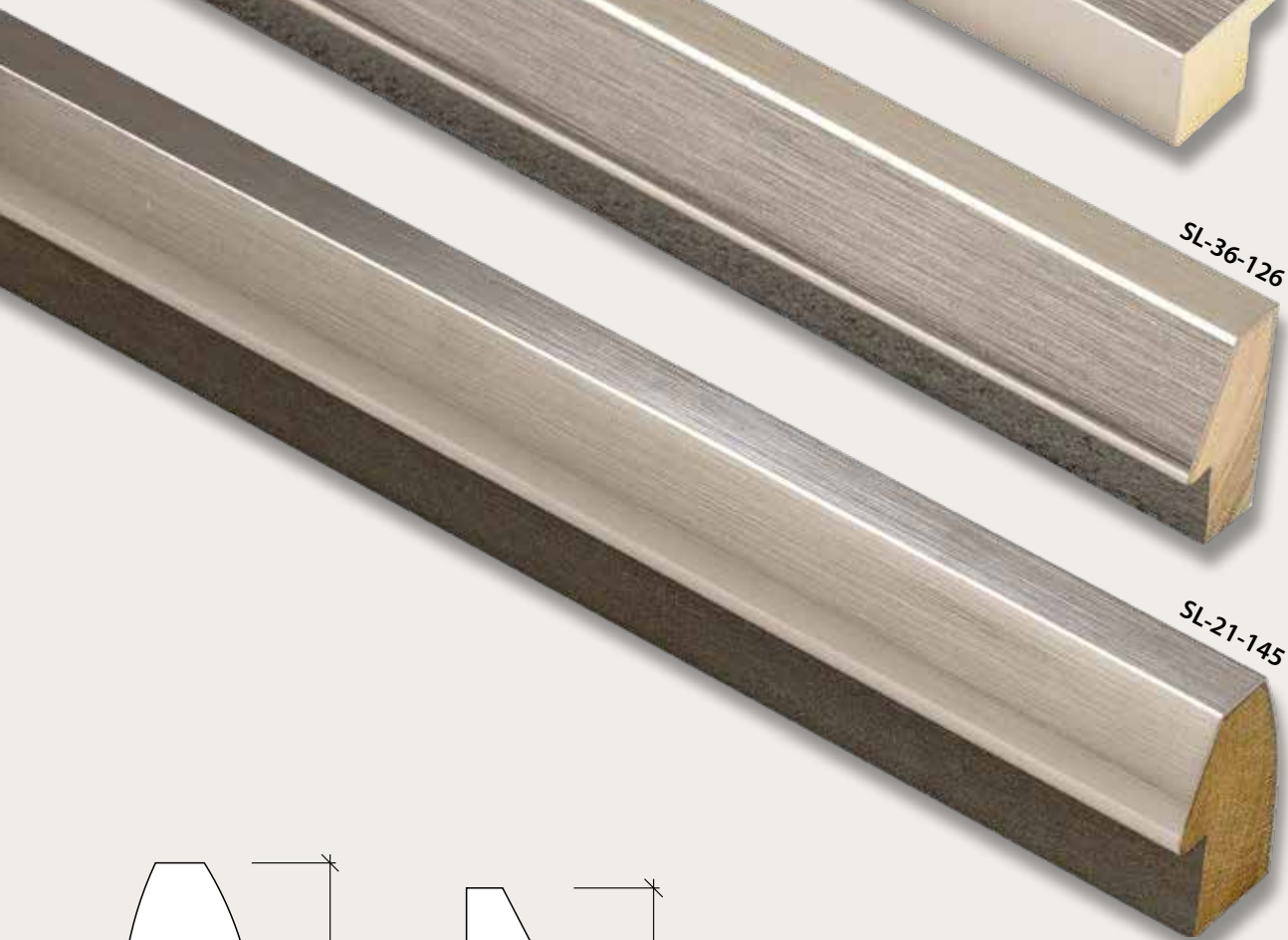

SL-21-145

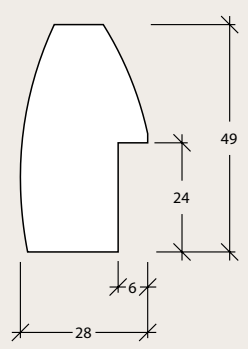

SL-21

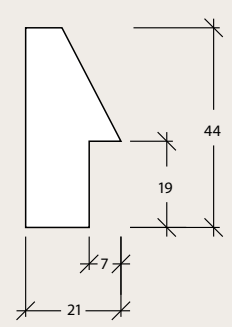

SL-36

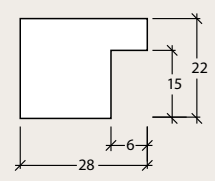

SL-12

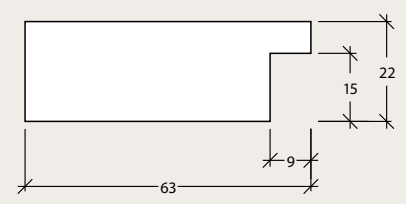

SL-58

4015-8185

5054-9014

5064-9106

3002-20

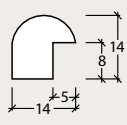

3002

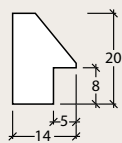

5064

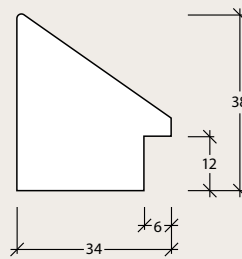

5054

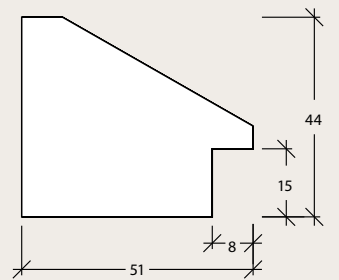

4015



4030-8426

122-8475

5032-8475

2016-1560

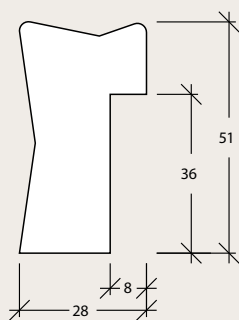

4030

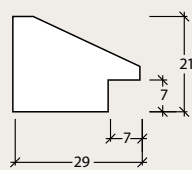

122

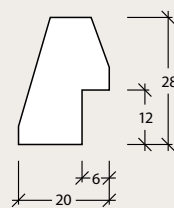

5032

6034-1134

2016-1134

3002-1134

2016-1136

3002-1136

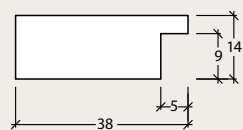

6034

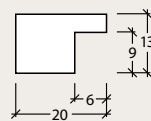

2016

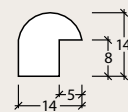

3002

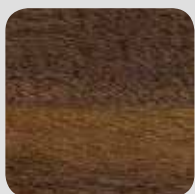

Imbuia Natural
Acabamento 8697

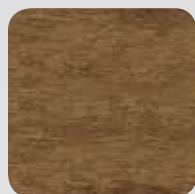

Imbuia Clara Natural
Acabamento 8969

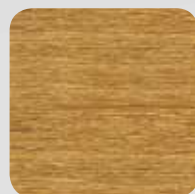

Cerejeira Natural
Acabamento 8696

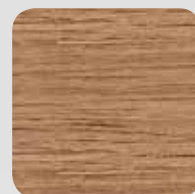

Jequitibá Natural
Acabamento 8968

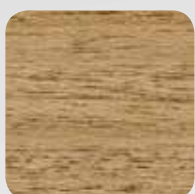

Freijó Natural
Acabamento 8970

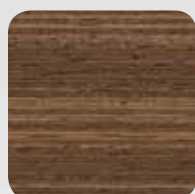

Imbuia Rajada
Acabamento 8370

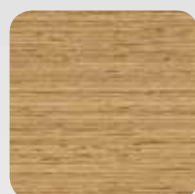

Freijó Escuro
Acabamento 8369

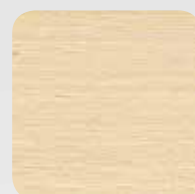

Marfim Linheiro
Acabamento 8403

Laminado

Laminated / Laminado



1510-8697



4058-8697



997-8697



1510-8969



4058-8969



997-8969

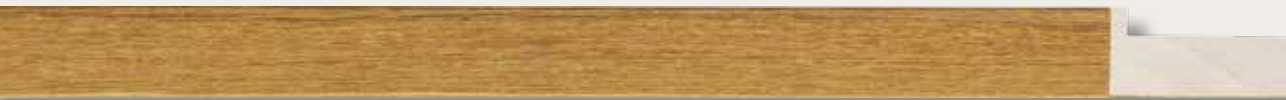

1510-8696

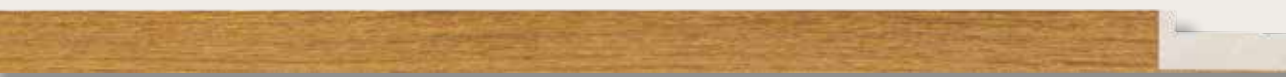

4058-8696



997-8696

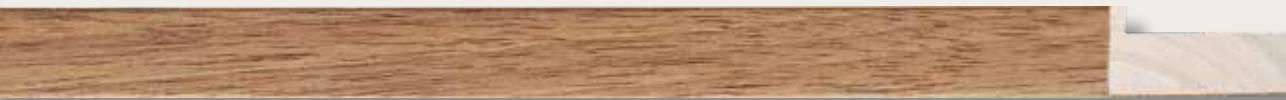

1510-8968



4058-8968



997-8968



1510-8970



4058-8970



997-8970

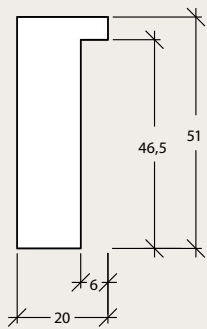

1510

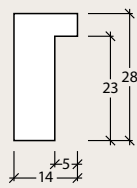

997

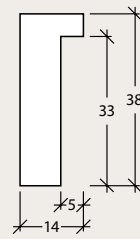

4058



1512-8370



1220-8370



997-8370



2098-8370



2021-8370



1512-8369



1220-8369



997-8369



2098-8369



2021-8369

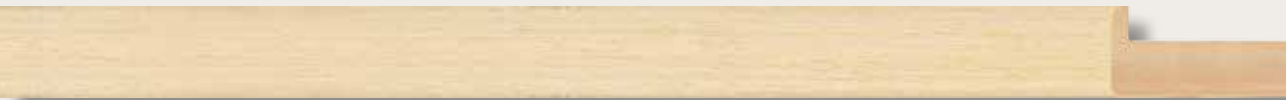

1512-8403



1220-8403

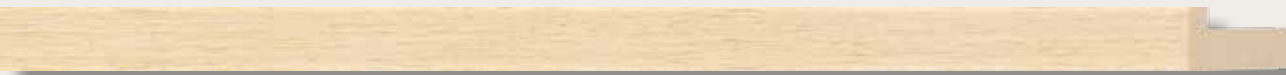

997-8403



2098-8403



2021-8403

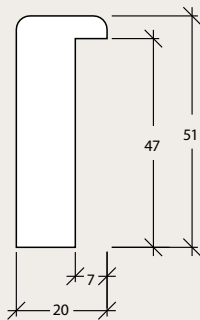

1512

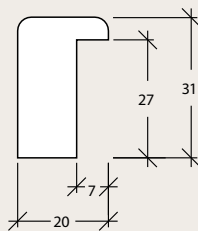

1220

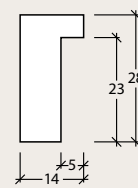

997

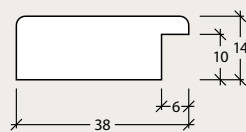

2098

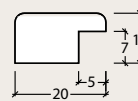

2021



Amadeirado

Woody / Amaderado

ALTO
BRILHO



5067-9151

ALTO
BRILHO



1510-9145



1510-GANO

ALTO
BRILHO

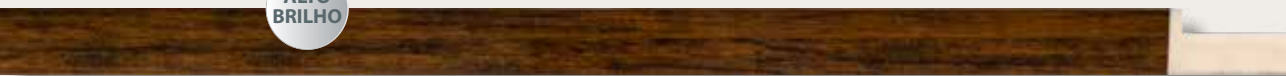

997-9145



1210-GANO

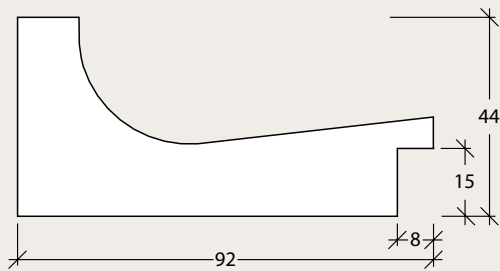

5067

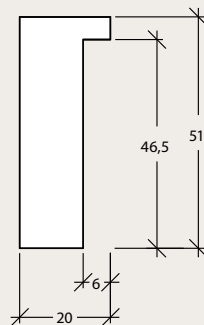

1510

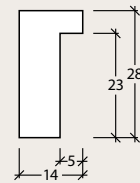

997

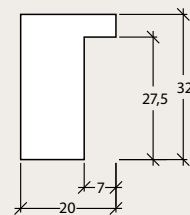

1210



8008-GANO



6034-GANO



2016-GANO



8008-HS 257



8007-HS 257

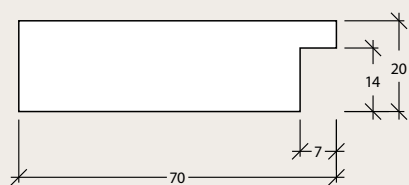

8008

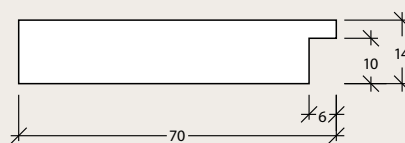

8007



5065-HS 257



1510-HS 257

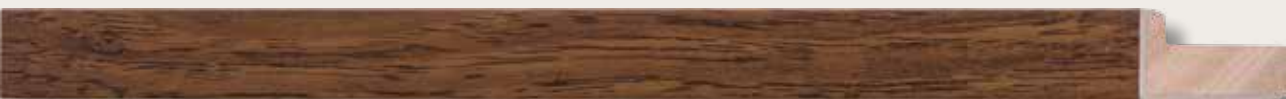

1210-HS 257



6034-HS 257



2016-HS 257



3043-HS 257

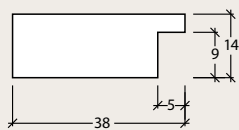

6034

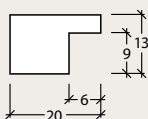

2016

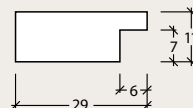

3043

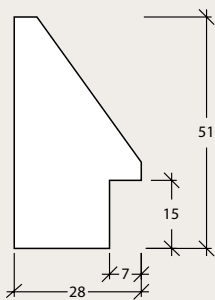

5065

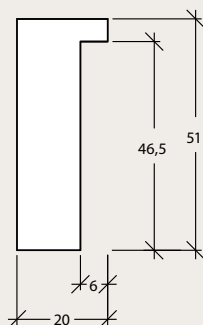

1510

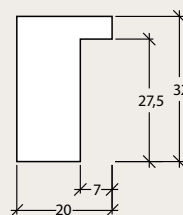

1210



8008-152-HS



6034-TABACO



1510-152-HS



1210-152-HS



2016-152-HS



3002-152-HS

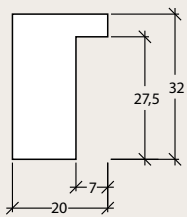

1210

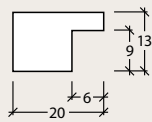

2016

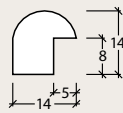

3002

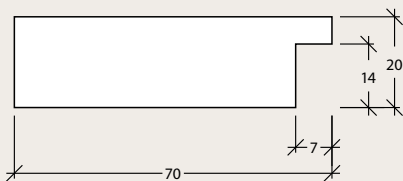

8008

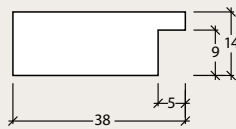

6034

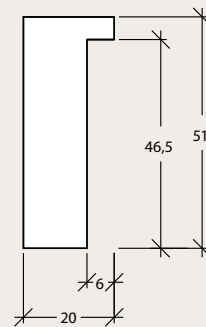

1510



KD-303-20



4054-8597



KD-302-42



5048-8924



SL-36-220



4033-8437

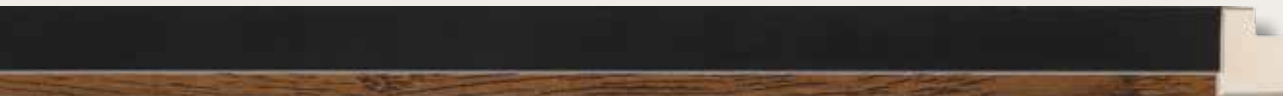

5039-8437

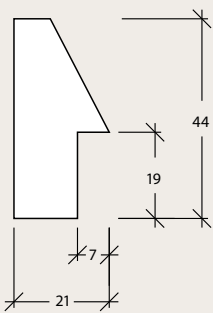

SL-36

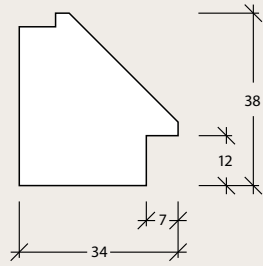

5048

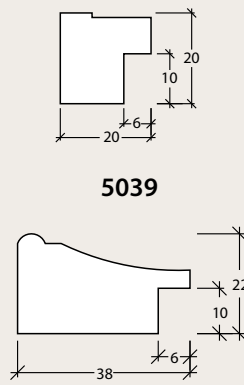

4054

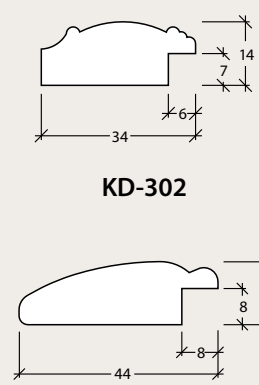

KD-303

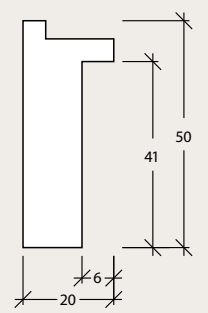

4033



3023-8306



3046-8670



3043-8682



3043-8698



ALTO
BRILHO

227-374



ALTO
BRILHO

227-288

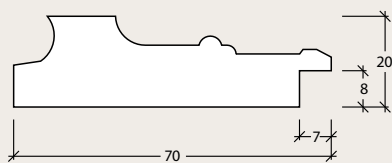

3023

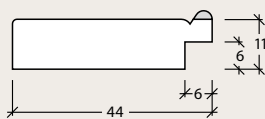

3046

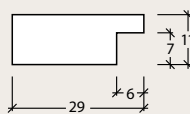

3043

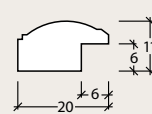

227



1210-9028



6034-9028



3057-9028



3057-9029



PINUS
SEM NÓ
E SEM
EMENDA

4062-8679



997-8616



997-8617



2016-CT4-A

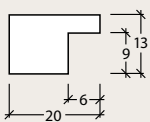

2016

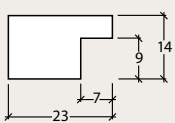

3057

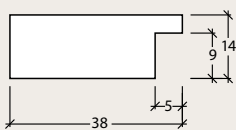

6034

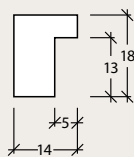

4062

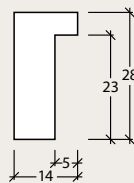

997

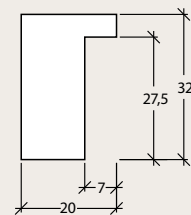

1210



3069-9126



3069-9125



3071-9118



3071-9117



1510-9064



1510-9065

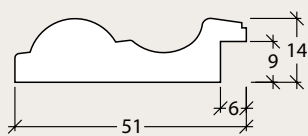

3069

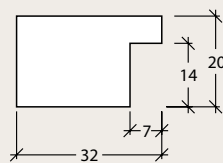

3071

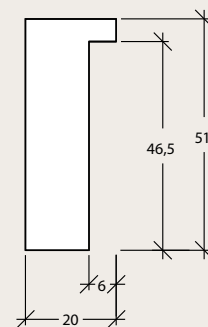

1510



5065-9127

PINUS SEM NÓ E SEM EMENDA



4058-9025

PINUS SEM NÓ E SEM EMENDA



4058-9026

PINUS SEM NÓ E SEM EMENDA



4058-8673

MADEIRA DO NORTE



4078-9027

PINUS SEM NÓ E SEM EMENDA



1210-8673

PINUS SEM NÓ E SEM EMENDA



4062-8673

PINUS SEM NÓ E SEM EMENDA



2016-8673

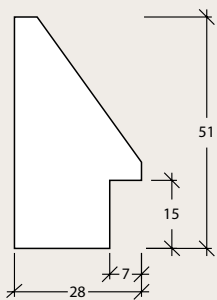

5065

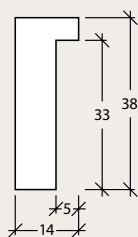

4058

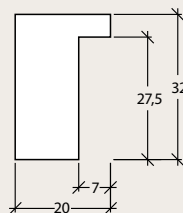

1210

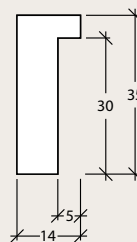

4078

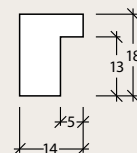

4062

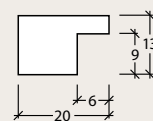

2016



Rústico

Rustic / Rústico



4077-9167



4077 - 9168



4077-9169

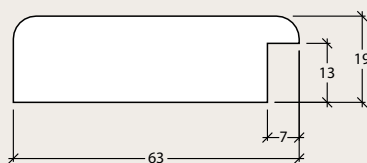

4077



3079-9182



3079-9183



3079-9184



3079-9185

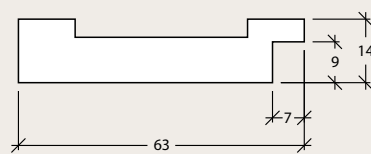

3079



5040-7656



5248-7656



98-7656



5040 TEKA



5248 TEKA



98 TEKA

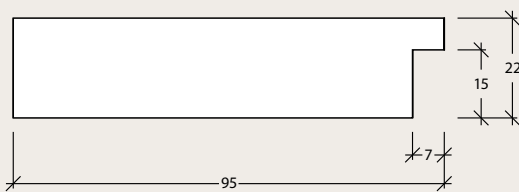

5040

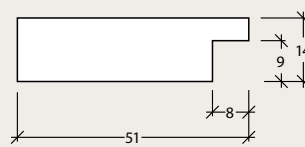

5248

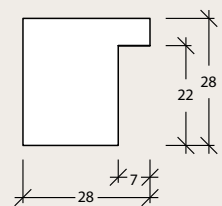

98



2011-8143



53-8143



2011-8142



53-8142

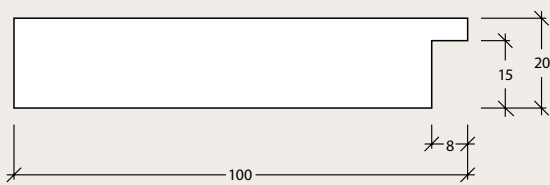

2011

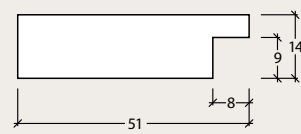

53



381-HS-AEM



380-HS-AEF



966-26C



6034-9041

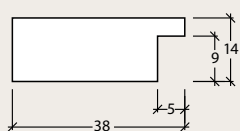

6034

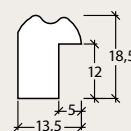

966

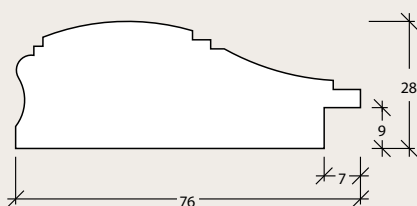

381



380



Provençal

Provence / Provenzal



3060-PRO



5248-7655



309-PRO



6059N-8257

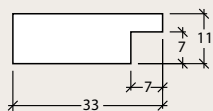

6059N

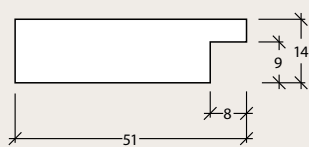

5248

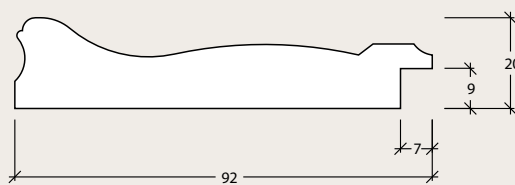

3060

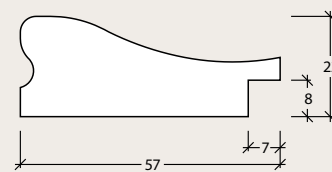

309



3047-PRO



E246-PRO



4013-8104



3069-PRO

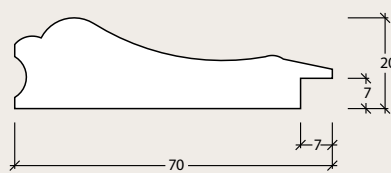

3047

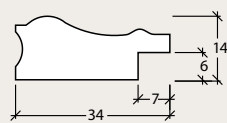

E246

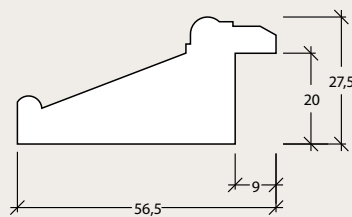

4013

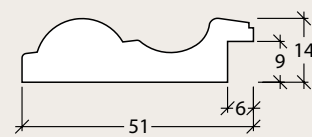

3069



3027-8411



2016-8471



380-9177



380-BRM



663N-PRO

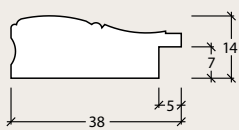

380

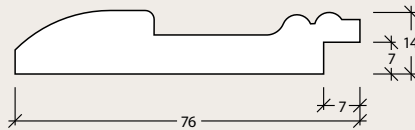

3027

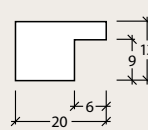

2016

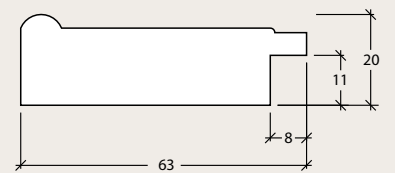

663N



Colorido

Colored / Colorido



3043-9069



3043-9068



3043-9099



3043-9100

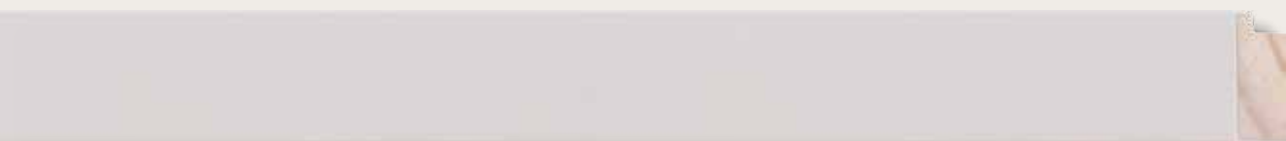

3043-9030

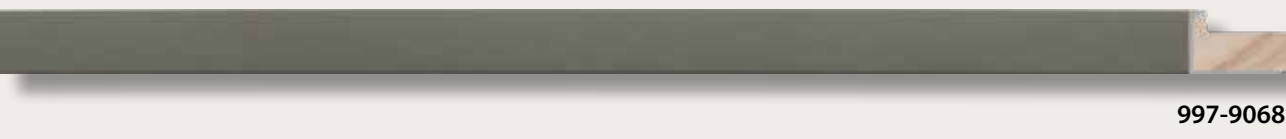

997-9068

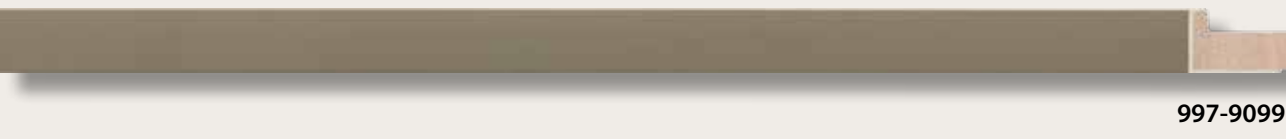

997-9099

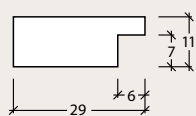

3043

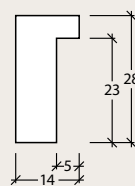

997

ALTO
BRILHO

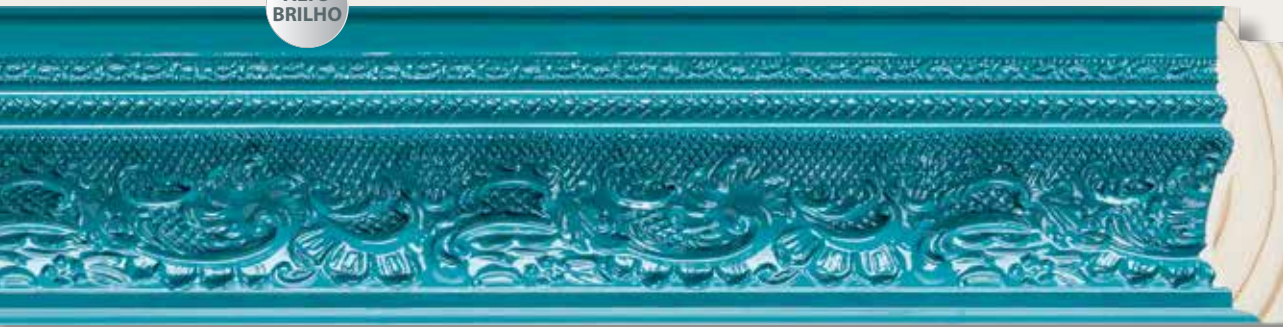

3073-8485

ALTO
BRILHO



2035-8485



2016-33



2016-9086



2016-34



2016-9087

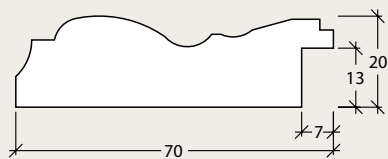

3073

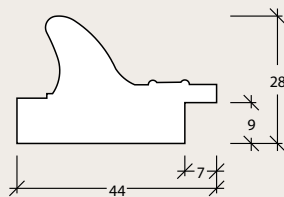

2035

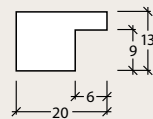

2016



997-8598



3043-8598



3002-33



ALTO BRILHO

227-512

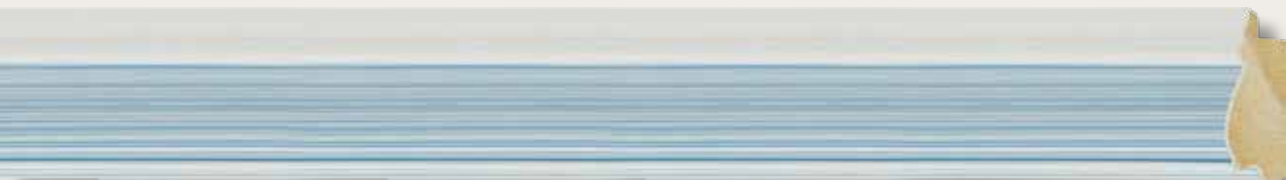

1448-407



2016-9090

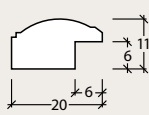

227

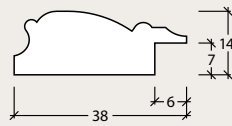

1448

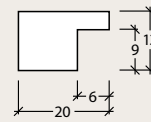

2016

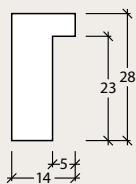

997

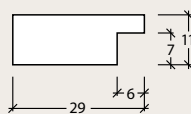

3043

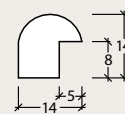

3002

ALTO BRILHO



3073-8486

ALTO BRILHO



2035-8486

ALTO BRILHO



1210-8486



997-8599



3002-23

ALTO BRILHO

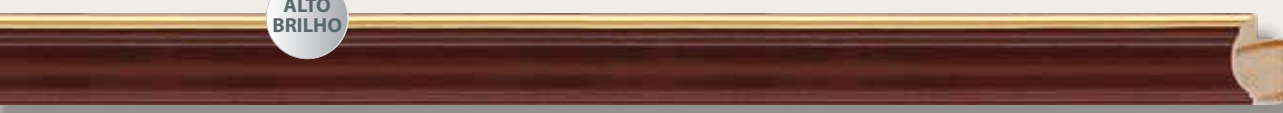

227-174

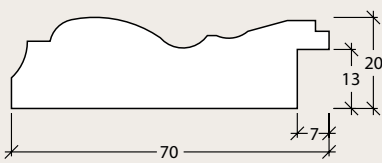

3073

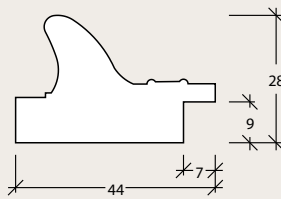

2035

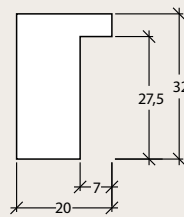

1210

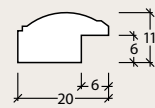

227



3043-9067



3043-8600

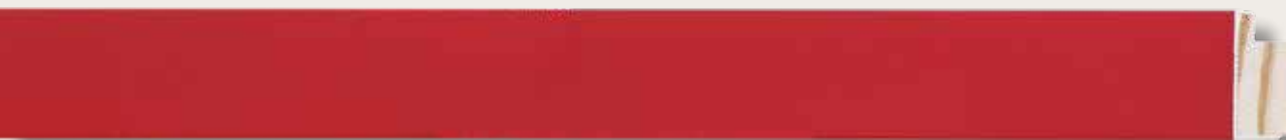

3043-8599



2016-23



2016-27



2016-8322



2016-9088



2016-9091

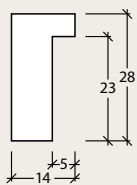

997

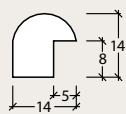

3002

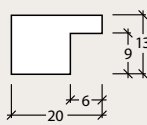

2016

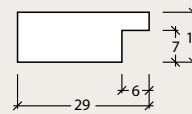

3043

ALTO
BRILHO



3073-8488

ALTO
BRILHO



2035-8488

ALTO
BRILHO



1210-8488

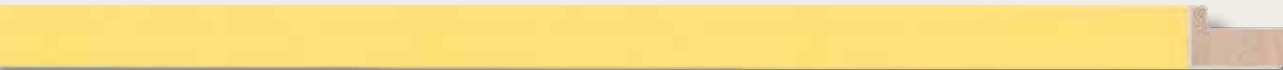

997-8601



2016-24

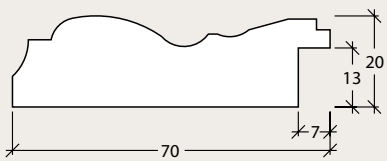

3073

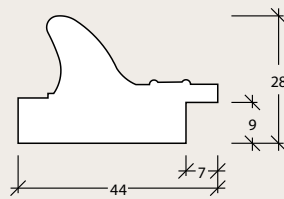

2035

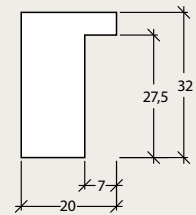

1210



3043-8601

ALTO
BRILHO



227-144



2016-GVF

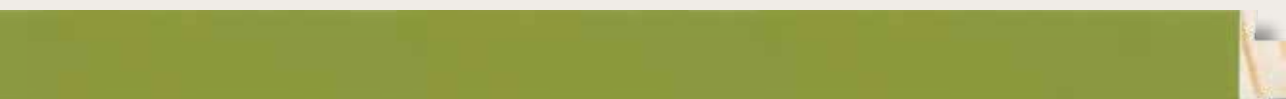

2016-26

ALTO
BRILHO



227-514

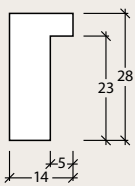

997

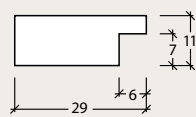

3043

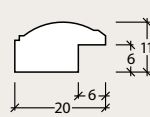

227

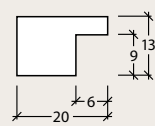

2016



Preto

Black / Negro



3073-49

ALTO
BRILHO



350-149

ALTO
BRILHO



2035-8365

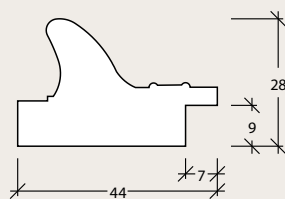

2035

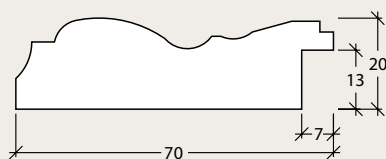

3073

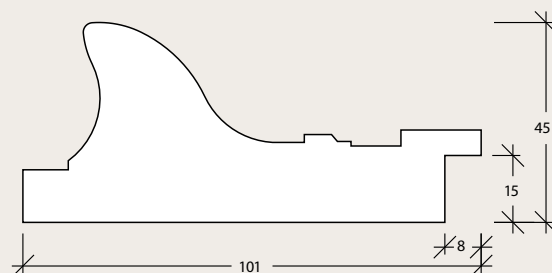

350



3060-9071



2233-PF

ALTO
BRILHO



3055-149

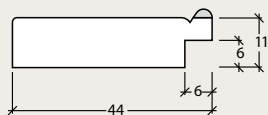

3055

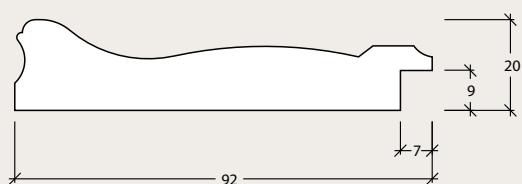

3060

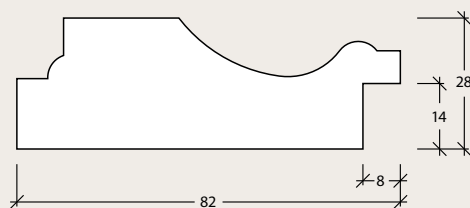

2233



329-49



3036-9178



78-49



5058-9056



5067-49

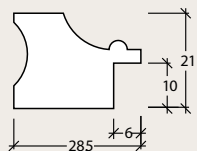

329

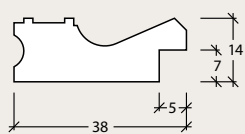

3036

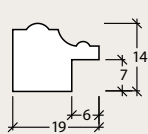

78

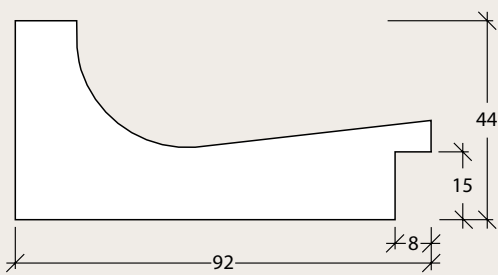

5067

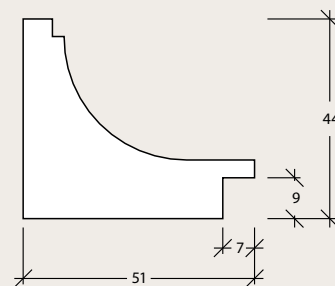

5058

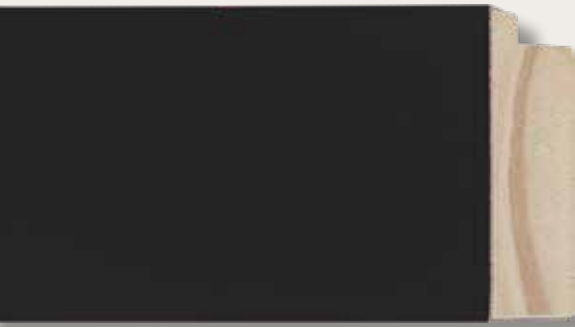

8008-49



5105-49



8007-49



8007-9104

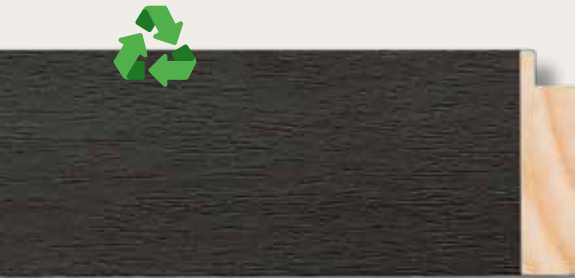

3070-9104



9N-9104

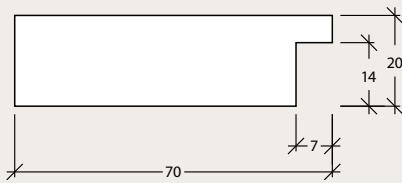

8008

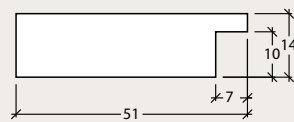

3070

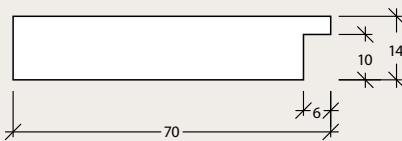

8007

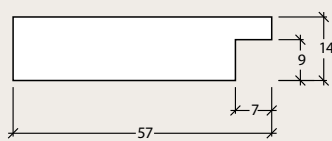

5105

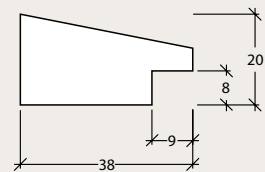

9N



6034-PRETO

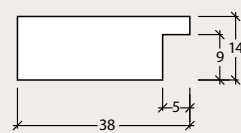

6034



2118-49

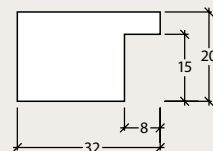

2118

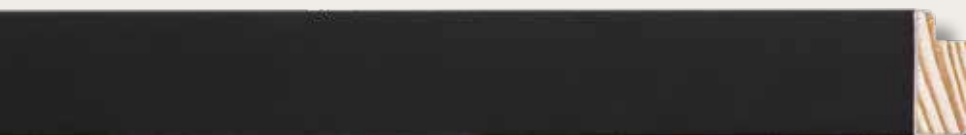

3043-49

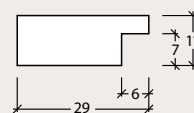

3043

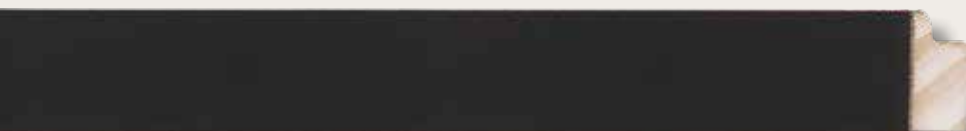

1428-49



1428-9104

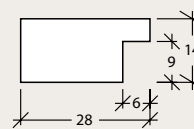

1428

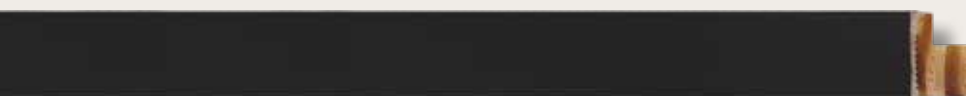

2016-49

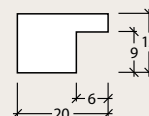

2016



2016-9104

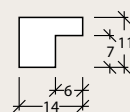

10



10-49



968-49



3067-49



1510-49



1510-9104

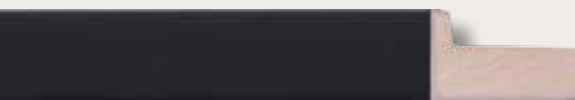

1210-49



1210-9104

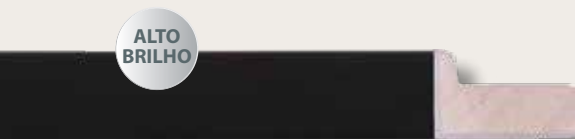

1210-149

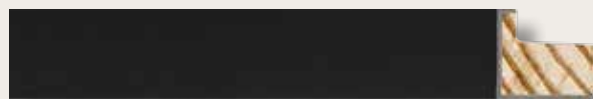

KD-309-01



98-49



98-9104

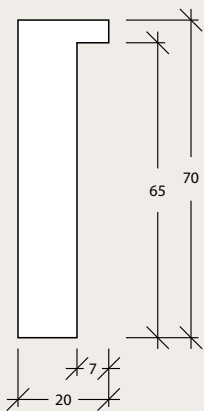

968

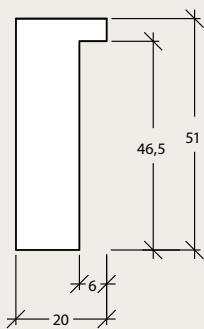

1510

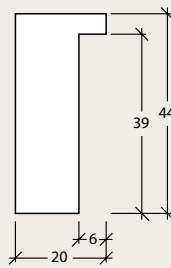

3067

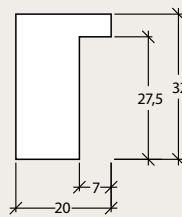

1210

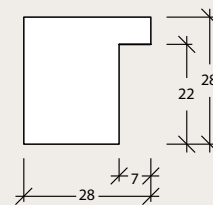

98

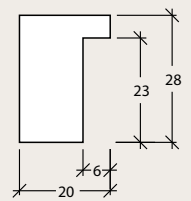

KD-309



4058-49



4058-9104



4078-01-49



997-49



4062-01-49

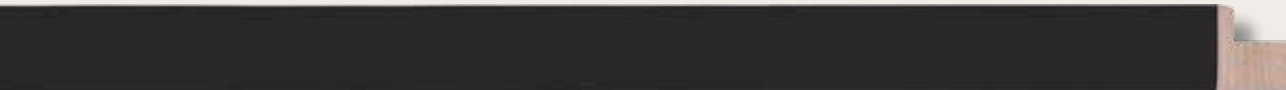

998-49

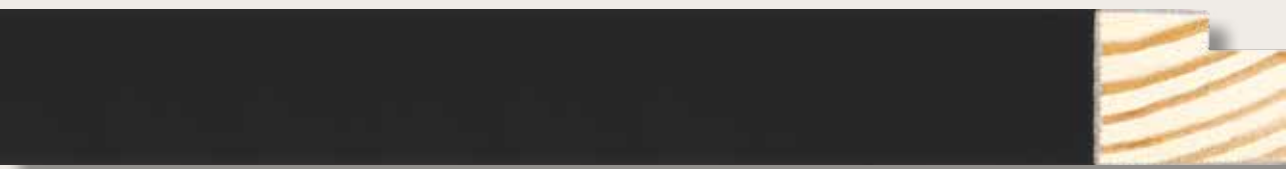

398-49

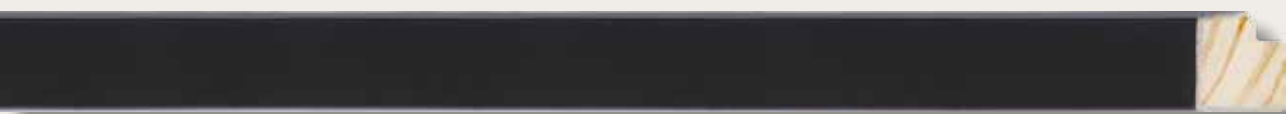

1109-49

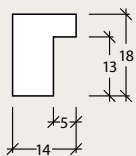

4062

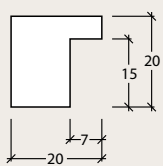

998

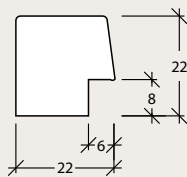

1109

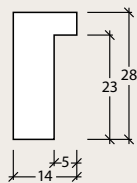

997

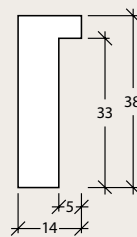

4058

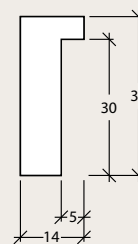

4078

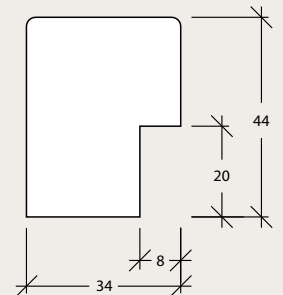

398



5066-49

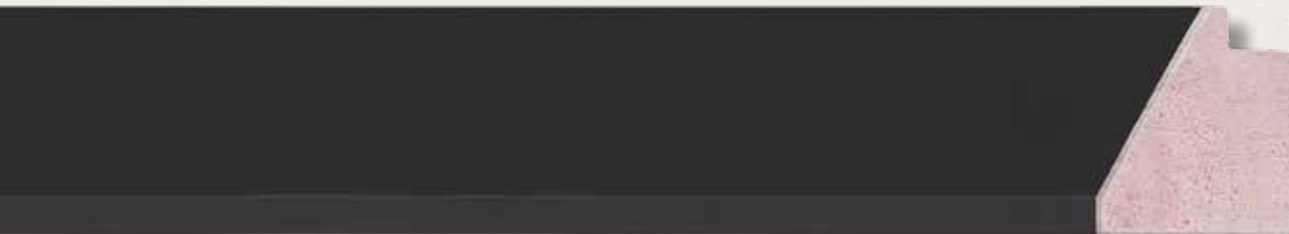

4015-49

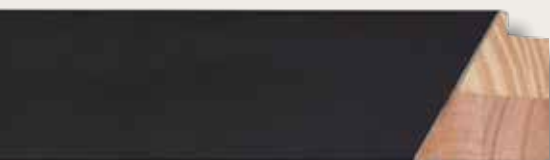

5054-49

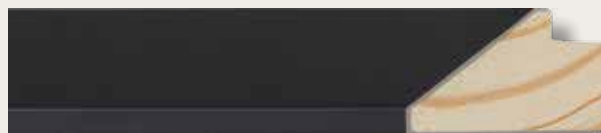

5065-49

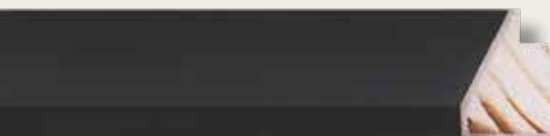

122-49



SL-36-101



5032-49

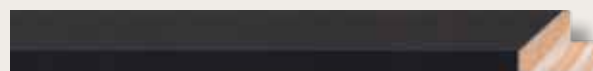

5064-49

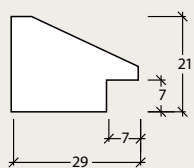

122

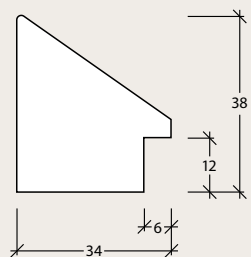

5054

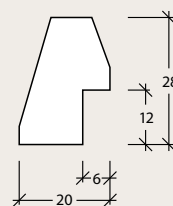

5032

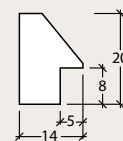

5064

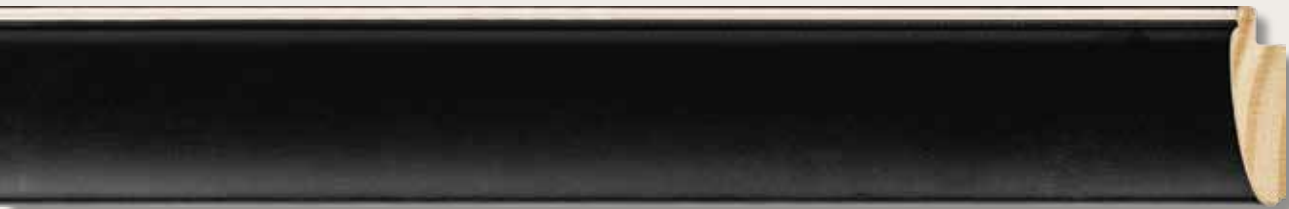

KD-303-15

ALTO BRILHO

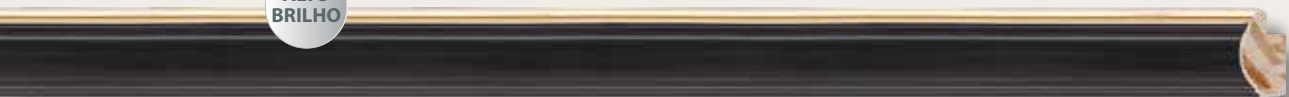

227-150

ALTO BRILHO



3002-149



3002-49

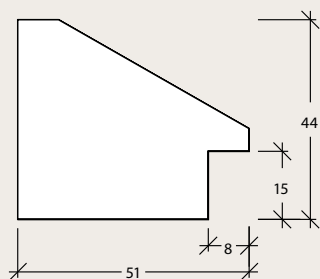

4015

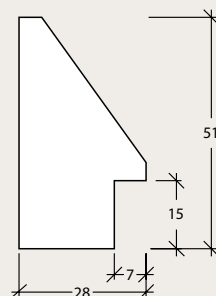

5065

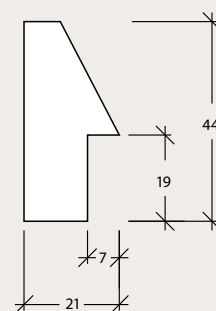

SL-36

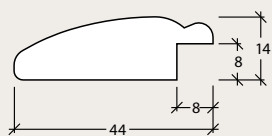

KD-303

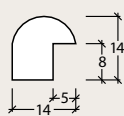

3002

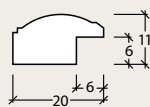

227

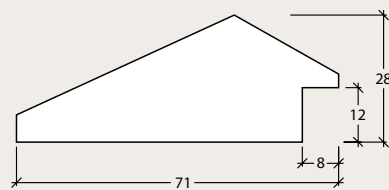

5066

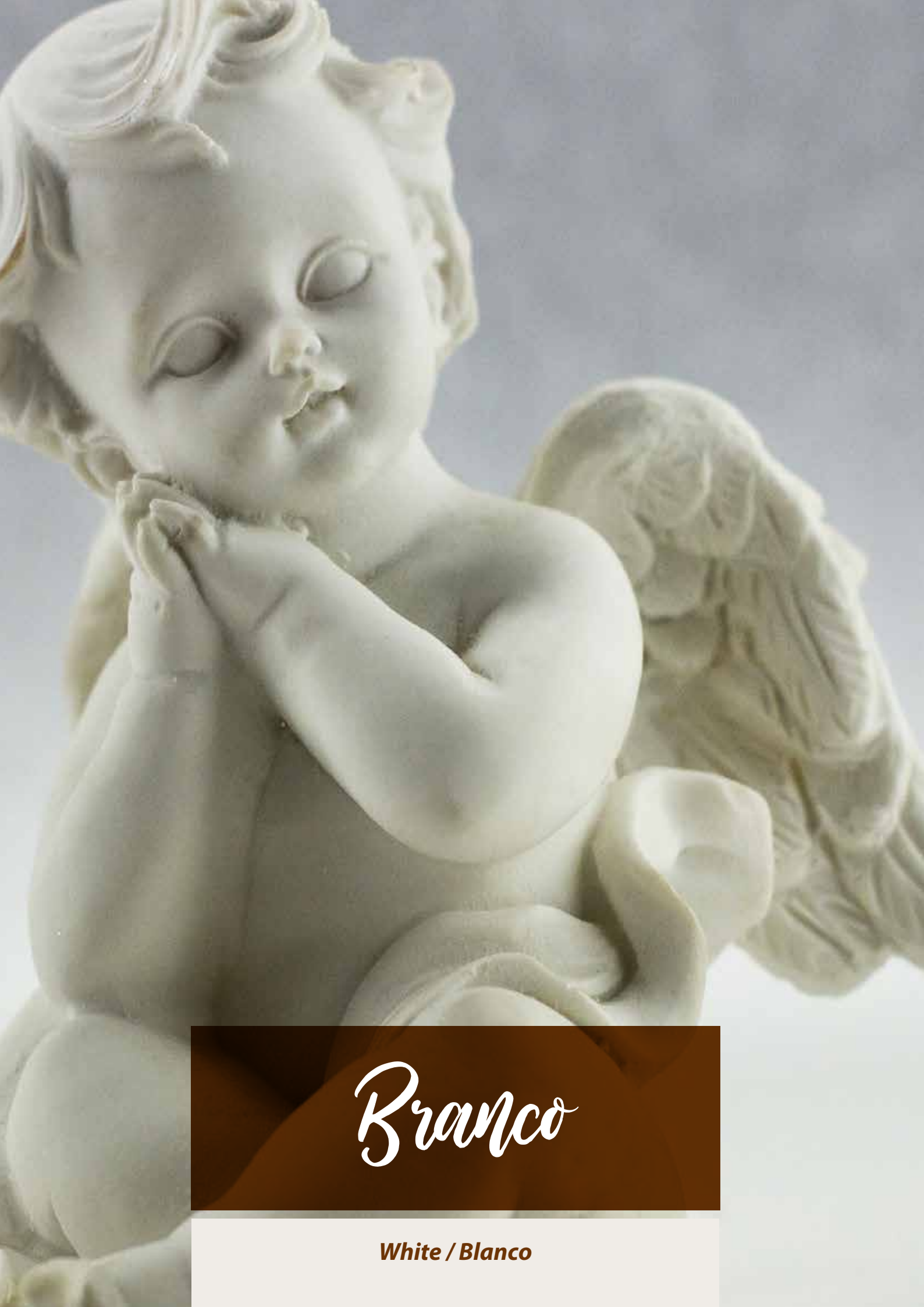

Branco

White / Blanco



3073-41

ALTO
BRILHO



350-141

ALTO
BRILHO



2035-141

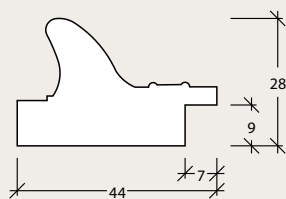

2035

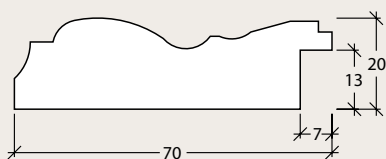

3073

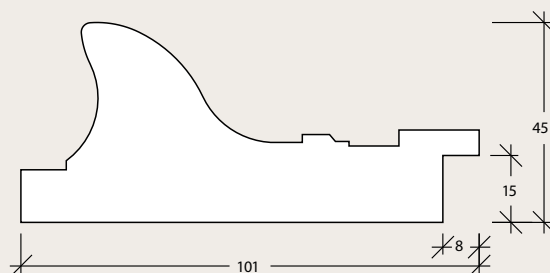

350



2233-01-41

ALTO
BRILHO



3055-141



78-41

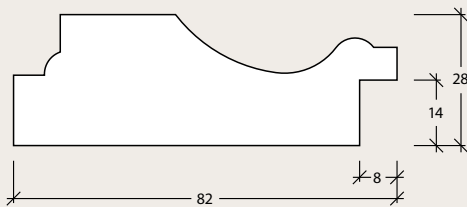

2233

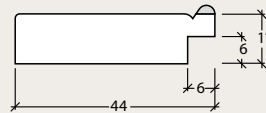

3055

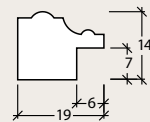

78



329-41



3033-8533



1448-41

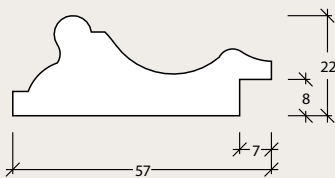

3033

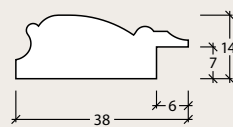

1448

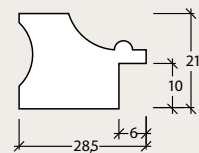

329

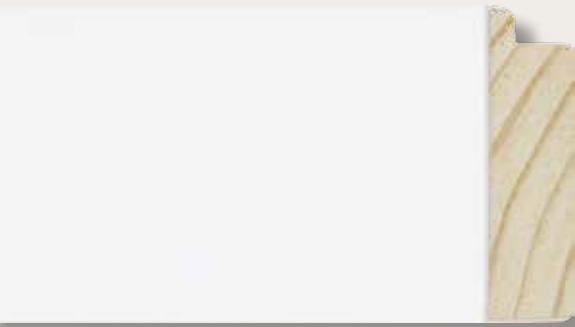

8008-41

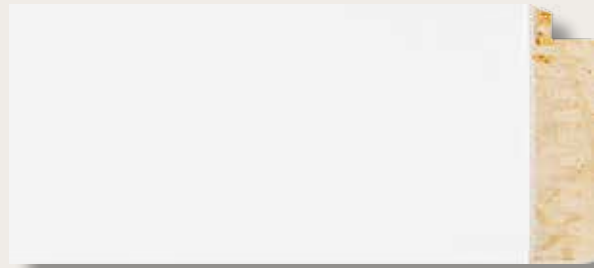

5105-41

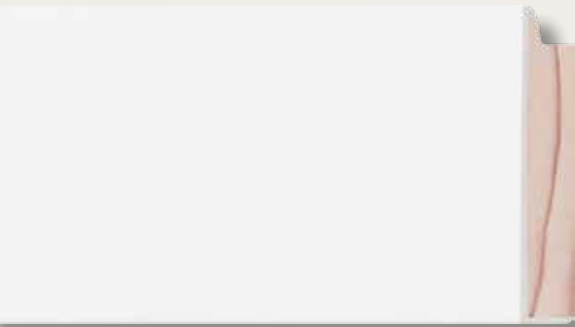

8007-41

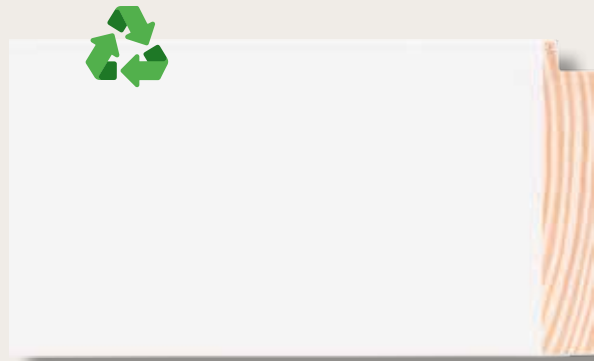

8007-9150

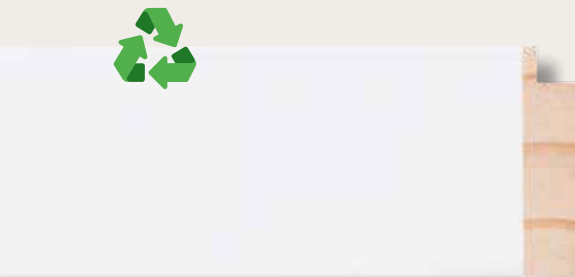

3070-9105

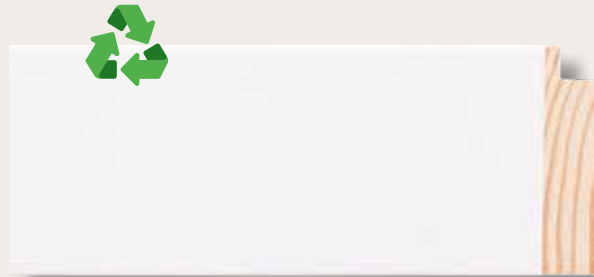

3070-9150



9N-9150

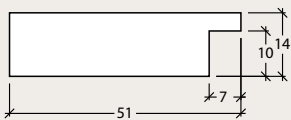

3070

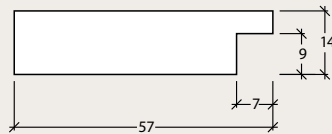

5105

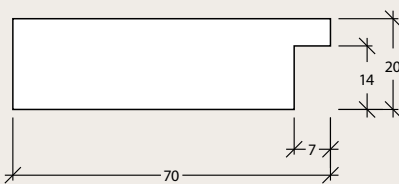

8008

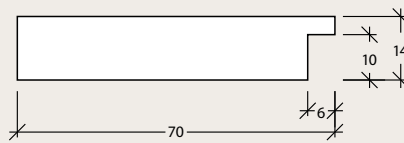

8007

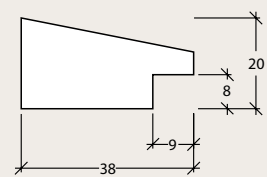

9N

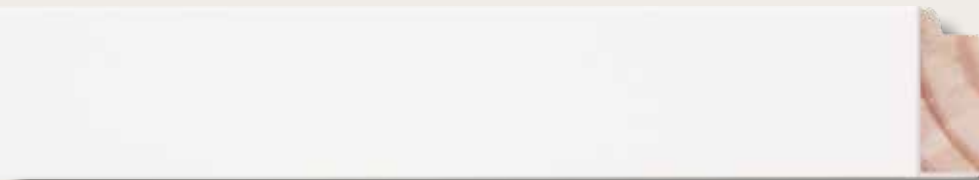

6034-BRANCO

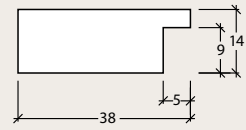

6034

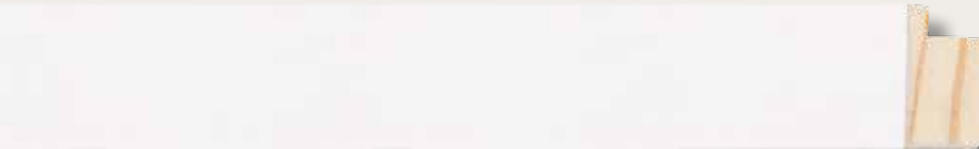

2118-41

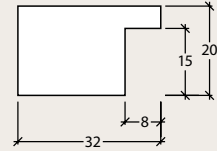

2118

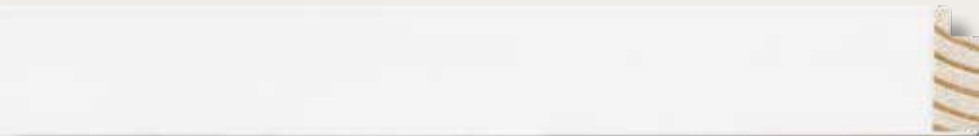

3043-41

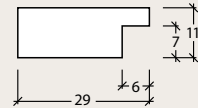

3043



1428-41

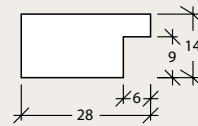

1428

1428-9150

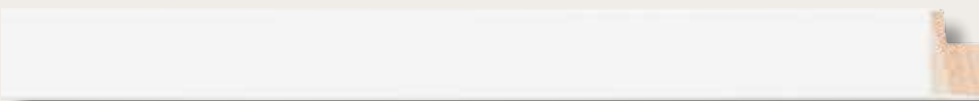

2016-41

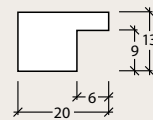

2016

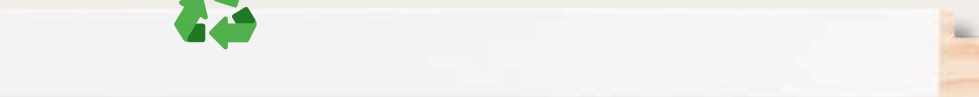

2016-9150

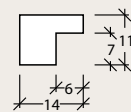

10

10-41



968-41

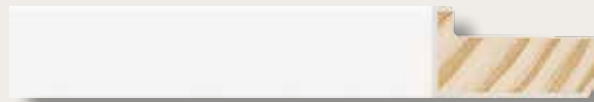

3067-41

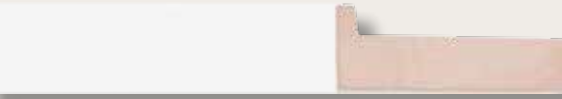

1510-41

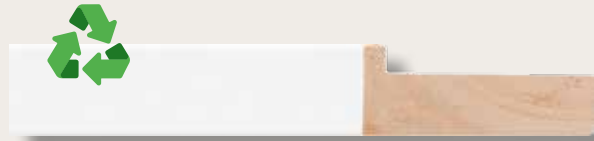

1510-9150

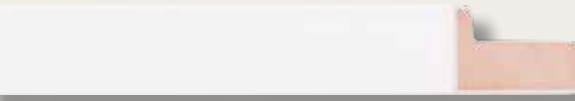

1210-41

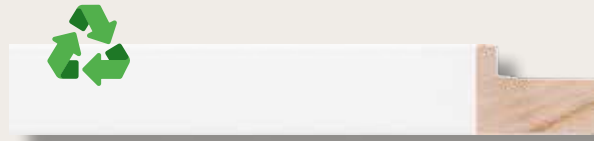

1210-9150

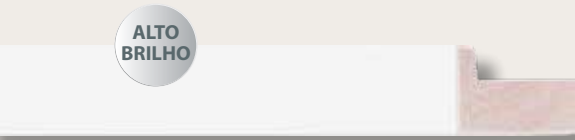

1210-141

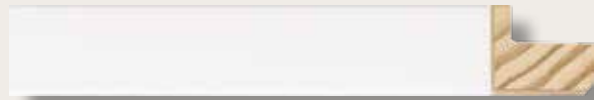

KD-309-02

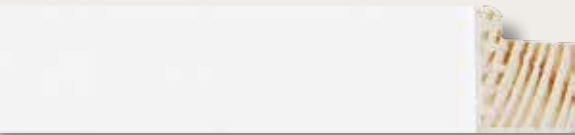

98-41

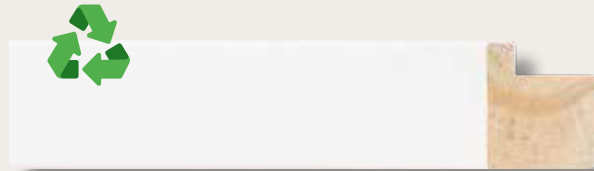

98-9150

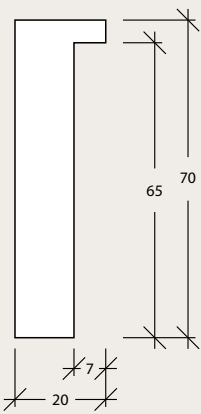

968

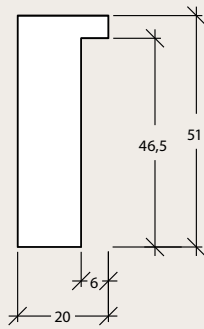

1510

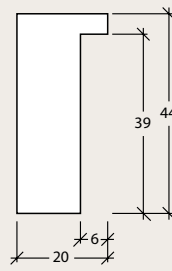

3067

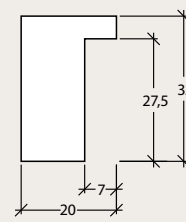

1210

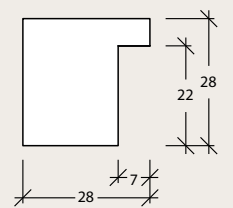

98

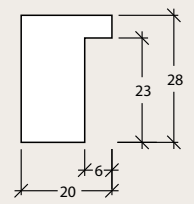

KD-309

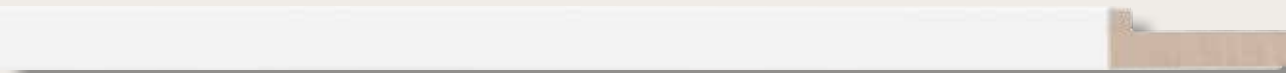

4058-41

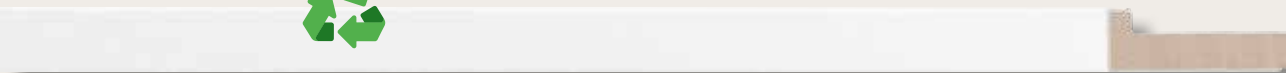

4058-9150



4078-01-41

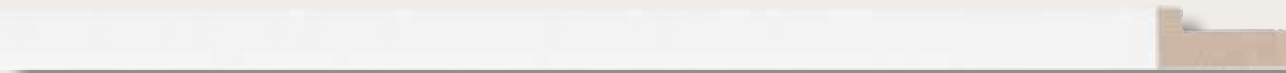

997-41

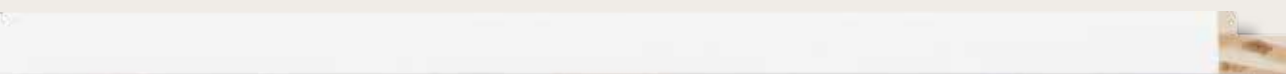

4062-01-41

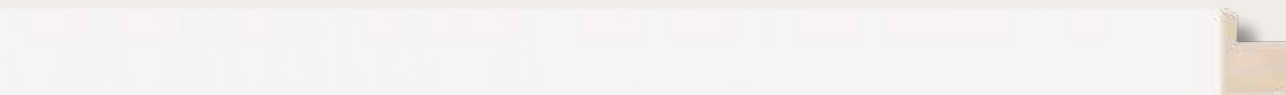

998-41

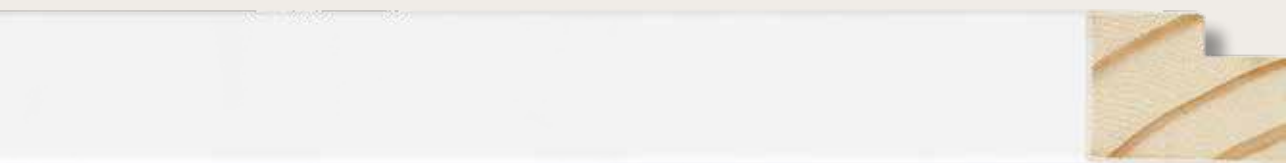

398-41

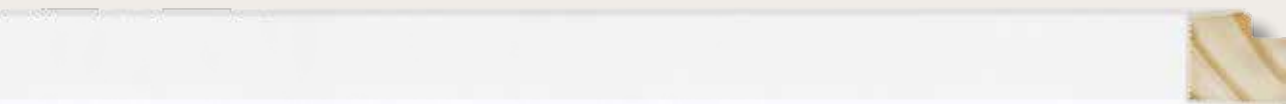

1109-41

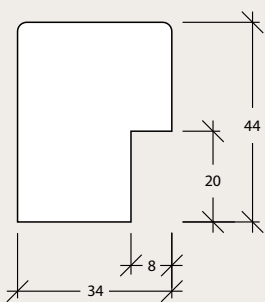

398

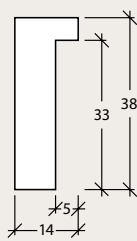

4058

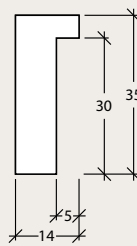

4078

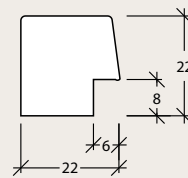

1109

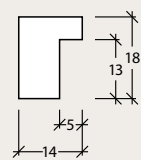

4062

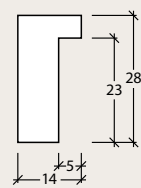

997

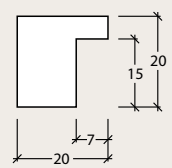

998

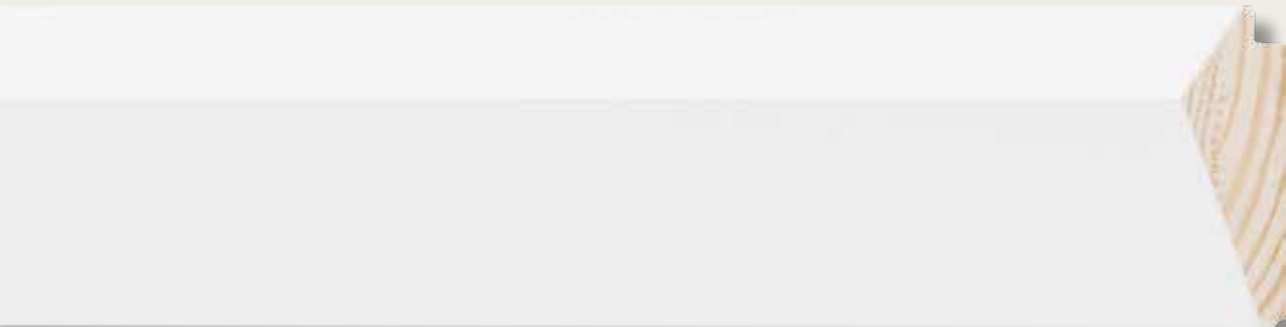

5066-41

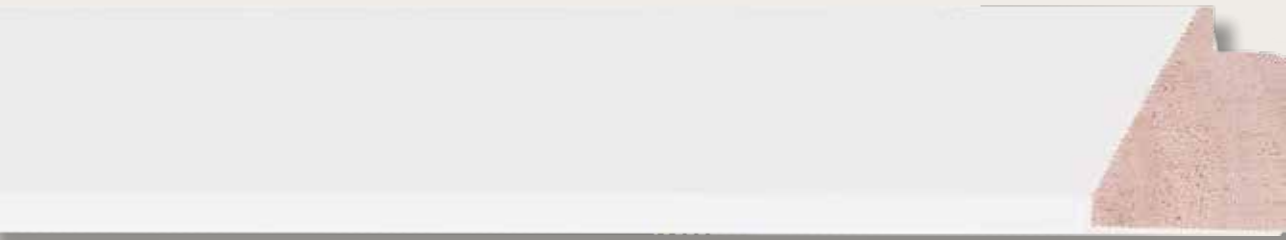

4015-41

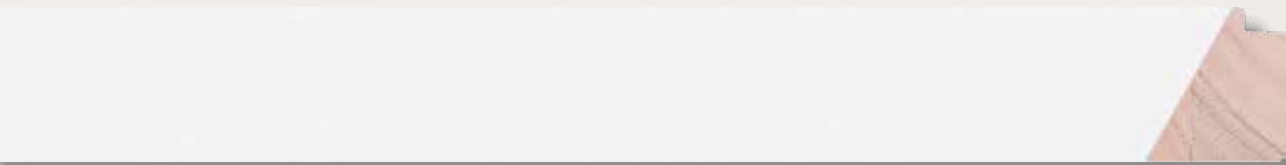

5054-41



5065-41

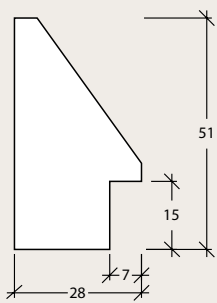

5065

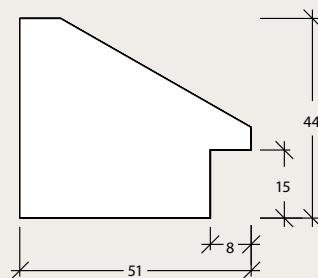

4015

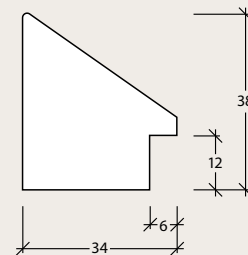

5054



122-41



5032-41



5064-41

ALTO BRILHO



227-142



3002-41

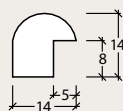

3002

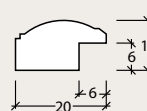

227

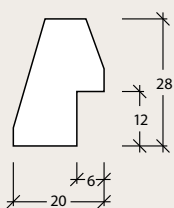

5032

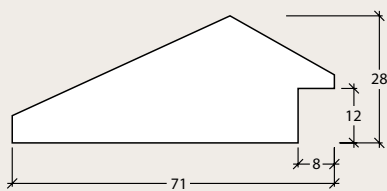

5066

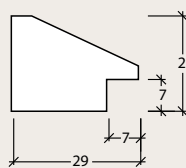

122

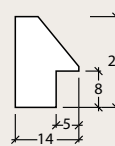

5064



Filetes e Passepartout

Fillet and Passepartout / Filete y Passepartout



3806-01-49

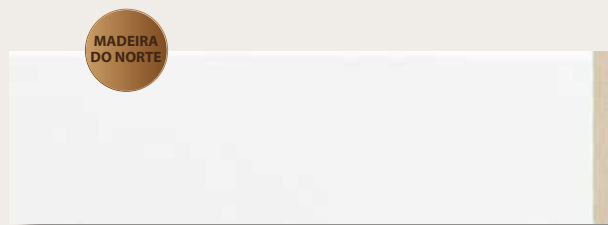

3806-01-41



1907N-01-49

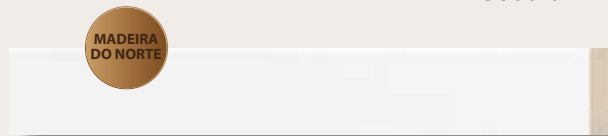

1907N-01-41



SL-01-209



5028-8456



3015-DLKH



40-NPS



SL-01-100



5028-8455



3015-DLYB

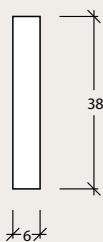

3806



1907N

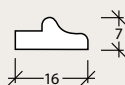

SL-01

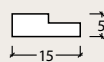

5028



3015

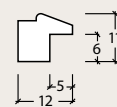

40



3066-9101



3066-9102



3066-9134



3066-VLI



3066-9103



3068-9101



3068-9102



3068-9134



3068-VLI

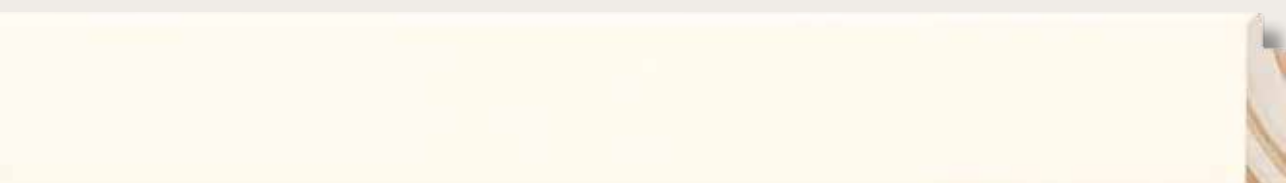

3068-9103

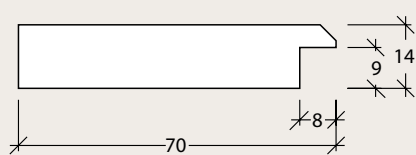

3066

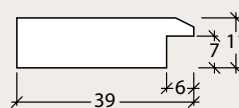

3068



938-MAF

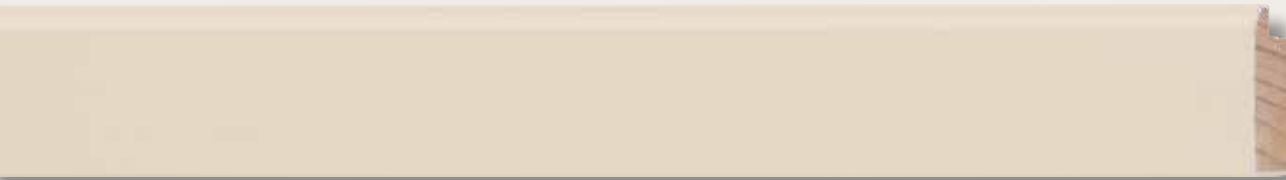

938-MA

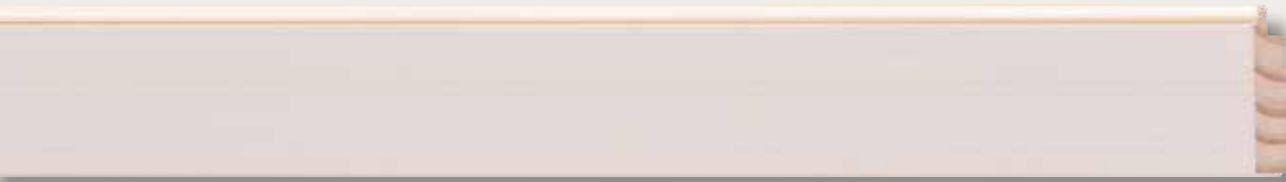

938-PVF



938-PV

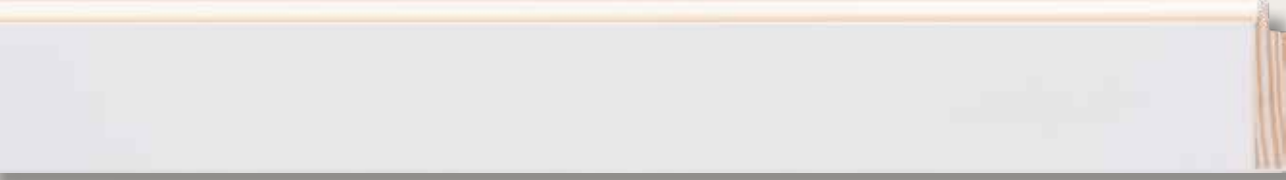

938-BFF

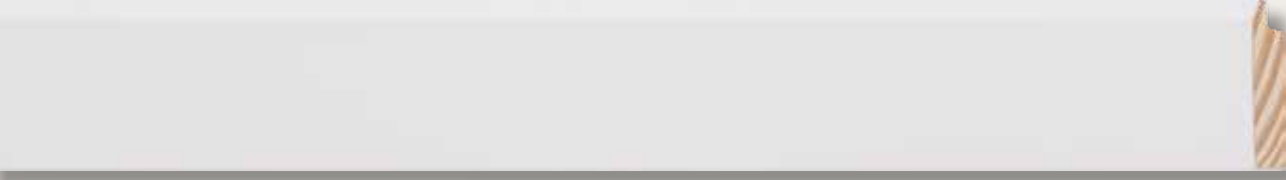

938-BF

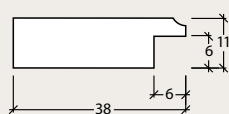

938



920-MAF



928-MAF



920-MA



928-MA



920-PVF



928-PVF



920-PV



928-PV



920-BFF



928-BFF



920-BF



928-BF



3046-8685



928-BFF



3046-8684

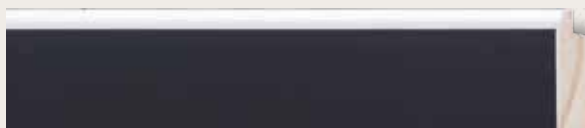

928-PFP

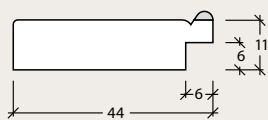

3046

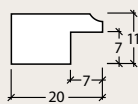

920

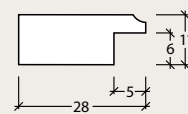

928



Canaletas e Complementos de Telas

Floater / Molduras para Enmarcar Telas



3074-01-49



3074-01-41



3074-9132



3076-01-41



3076-01-49

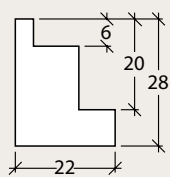

3074

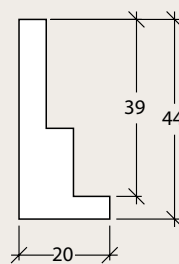

3076

MADEIRA
DO NORTE



2074N-01-49

MADEIRA
DO NORTE



2074N-01-41



2074N-9111

MADEIRA
DO NORTE



2074N-8674

PINUS
SEM NÓ
E SEM
EMENDA



2074N-8673

MADEIRA
DO NORTE



2074N-9027

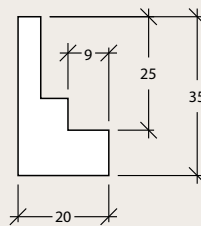

2074N

MADEIRA
DO NORTE



5003N-01-49

MADEIRA
DO NORTE

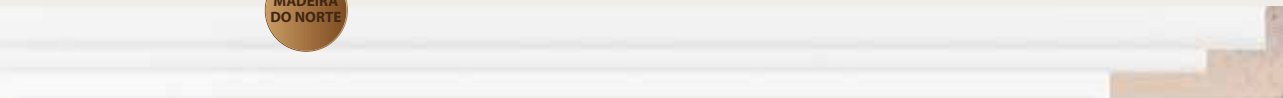

5003N-01-41



5003N-9028



5003N-9029

PINUS
SEM NÓ
E SEM
EMENDA



5003N-8673

MADEIRA
DO NORTE



5003N-9027

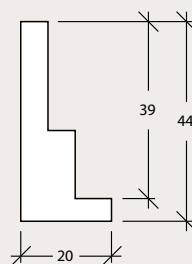

5003N



Chassis

Stretcher Bar / Bastidor

CHASSI EM
EUCALIPTO



2004-01

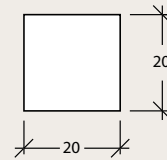

2004



Chassi-2x2

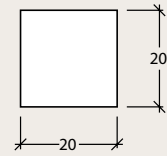

Chassi - 2x2



Chassi-3x1,5-CH

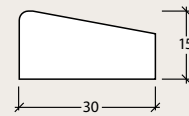

Chassi - 3x1,5



Chassi-20x33-CH

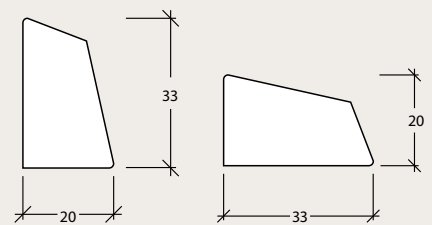

Chassi - 20x33-CH



Chassi-20x38-CH

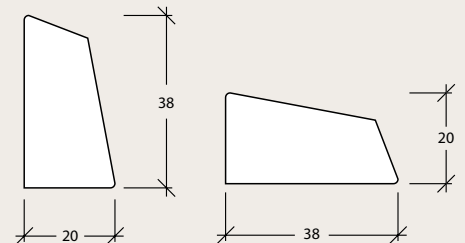

Chassi 20x38-CH



Chassi-20x38-CH



Chassi-20x48-CH

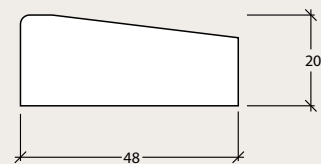

Chassi - 20x48-CH



CHASSI EM
EUCALIPTO



2011-01

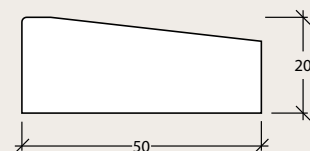

Chassi 2011

Índice por producto

Product Index / Índice por Producto

10-41	107	1907N-01-49	113	2066-9003	17	3043-8682	70
10-49	97	2004-01	123	2066-9004	37	3043-8698	70
10-9054	52	2011-01	123	2072-9160	9	3043-9030	85
10-9142	48	2011-8142	78	2072-9161	9	3043-9067	89
10-9144	47	2011-8143	78	2072-9162	31	3043-9068	85
10-9146	49	2016-1134	57	2074N-01-41	120	3043-9069	85
1034-47	22	2016-1136	57	2074N-01-49	120	3043-9099	85
1109-41	109	2016-152-HS	68	2074N-8673	120	3043-9100	85
1109-49	99	2016-1560	56	2074N-8674	120	3043-HS257	67
117-38547	42	2016-23	89	2074N-9027	120	3046-8670	70
1210-141	108	2016-24	90	2074N-9111	120	3046-8684	117
1210-149	98	2016-26	91	2098-8369	62	3046-8685	117
1210-152-HS	68	2016-27	89	2098-8370	62	3047-PRO	82
1210-1979	40	2016-301	23	2098-8403	63	3055-141	104
1210-41	108	2016-302	45	2118-41	107	3055-149	94
1210-49	98	2016-33	86	2118-49	97	3055-8995	14
1210-5159	24	2016-34	86	2151-1548	21	3055-8996	35
1210-8401	40	2016-41	107	2233-01-41	104	3057-9028	71
1210-8486	88	2016-47	45	2233-1548	20	3057-9029	71
1210-8488	90	2016-49	97	2233-PF	94	3060-9071	94
1210-8547	40	2016-59	26	2266N-1548	20	3060-9072	12
1210-8673	73	2016-8322	89	227-142	111	3060-9073	33
1210-9028	71	2016-8469	45	227-144	91	3060-PRO	81
1210-9104	98	2016-8470	27	227-150	101	3066-9101	114
1210-9150	108	2016-8471	83	227-174	88	3066-9102	114
1210-9170	50	2016-8673	73	227-236	25	3066-9103	114
1210-GANO	65	2016-9086	86	227-288	70	3066-9134	114
1210-HS-65	40	2016-9087	86	227-374	70	3066-VLI	114
1210-HS257	67	2016-9088	89	227-512	87	3067-41	108
122-41	111	2016-9090	87	227-514	91	3067-49	98
122-49	100	2016-9091	89	227-8531	53	3068-9101	115
122-5159	24	2016-9104	97	270N-237	10	3068-9102	115
122-8184	50	2016-9150	107	3002-1134	57	3068-9103	115
122-8475	56	2016-9163	23	3002-1136	57	3068-9134	115
1220-8369	62	2016-9164	45	3002-149	101	3068-VLI	115
1220-8370	62	2016-CT4-A	71	3002-152-HS	68	3069-9107	34
1220-8403	63	2016-GANO	66	3002-20	55	3069-9108	14
1428-41	107	2016-GVF	91	3002-21	50	3069-9109	34
1428-49	97	2016-HS-65	43	3002-23	88	3069-9125	72
1428-9104	97	2016-HS257	67	3002-31	25	3069-9126	72
1428-9150	107	2021-8369	62	3002-33	87	3069-PRO	82
1448-35	25	2021-8370	62	3002-41	111	3070-9104	96
1448-407	87	2021-8403	63	3002-49	101	3070-9105	106
1448-41	105	2035-141	103	3015-DLKH	113	3070-9150	106
149-500	22	2035-8363	32	3015-DLYB	113	3071-9117	72
1510-152-HS	68	2035-8364	15	3023-8306	70	3071-9118	72
1510-41	108	2035-8365	93	3023-8307	21	3073-41	103
1510-49	98	2035-8485	86	3027-8411	83	3073-49	93
1510-8696	60	2035-8486	88	3027-8412	20	3073-8485	86
1510-8697	59	2035-8488	90	3028-8438	14	3073-8486	88
1510-8968	60	2035-8931	15	3033-8533	105	3073-8488	90
1510-8969	59	2035-8932	32	3033-8534	44	3073-9119	14
1510-8970	61	2037-8366	12	3033-8535	19	3073-9120	34
1510-8979	24	2037-8367	31	3033-8536	19	3074-01-41	119
1510-9064	72	2042-8407	39	3034-8537	44	3074-01-49	119
1510-9065	72	2042-8408	39	3034-8538	21	3074-9132	119
1510-9104	98	2043-8409	39	3034-8539	21	3075-9135	15
1510-9145	65	2043-8410	23	3036-8542	19	3075-9136	38
1510-9150	108	2044-8427	10	3036-9178	95	3076-01-41	119
1510-GANO	65	2044-8428	30	3036-9179	19	3076-01-49	119
1510-HS-65	40	2046-8497	8	3036-9181	35	3079-9182	76
1510-HS257	67	2055-8589	12	3043-41	107	3079-9183	76
1512-8369	62	2055-8590	33	3043-49	97	3079-9184	76
1512-8370	62	2059-8663	13	3043-8598	87	3079-9185	76
1512-8403	63	2059-8664	33	3043-8599	89	309-47	38
180-G59G	18	2063-8409	32	3043-8600	89	309-PRO	81
1907N-01-41	113	2063-8410	15	3043-8601	91	329-41	105

329-49	95	5003N-8673	121	6034-9146	49	997-8369	62
329-52	15	5003N-9027	121	6034-BRANCO	107	997-8370	62
329-9172	15	5003N-9028	121	6034-GANO	66	997-8403	63
329-9173	35	5003N-9029	121	6034-HS257	67	997-8598	87
350-10	11	5028-8455	113	6034-PRETO	97	997-8599	88
350-141	103	5028-8456	113	6034-TABACO	68	997-8601	90
350-149	93	5032-41	111	6059N-8257	81	997-8616	71
350-8931	11	5032-49	100	6059N-8259	27	997-8617	71
350-8932	32	5032-8475	56	663N-PRO	83	997-8696	60
354-12	16	5032-8476	51	720-47	22	997-8697	59
354-13	36	5033-8479	22	78-41	104	997-8968	60
380-9175	18	5039-8437	69	78-49	95	997-8969	59
380-9176	35	5039-8628	41	78-9066	45	997-8970	61
380-9177	83	5039-9013	41	78-ONS	27	997-9068	85
380-BRM	83	5040-7656	77	8007-41	106	997-9099	85
380-HS-AEF	79	5040-TEKA	77	8007-49	96	997-9145	65
380-R59	18	5044-8637	27	8007-9104	96	998-41	109
3806-01-41	113	5044-8638	45	8007-9150	106	998-49	99
3806-01-49	113	5044-8639	27	8007-HS257	66	998-9170	50
381-GR420	18	5045-8670	27	8008-152-HS	68	Chassi 20x38-CH	123
381-HS-AEM	79	5045-8671	38	8008-41	106	Chassi 2x2 Reto	123
398-41	109	5048-8924	69	8008-49	96	Chassi 3x1,5 CH	123
398-49	99	5048-8927	24	8008-GANO	66	Chassi 20x33-CH	123
40-NPS	113	5050-8975	52	8008-HS257	66	Chassi 20x48-CH	123
4013-8104	82	5054-41	110	81-215	39	E246-PRO	82
4015-41	110	5054-49	100	81-9152	26	G7S	13
4015-49	100	5054-9013	53	81-HS-59	26	G7S-9137	13
4015-8184	50	5054-9014	55	9N-9054	51	G7S-9138	13
4015-8185	55	5058-9056	95	9N-9104	96	G7S-9139	34
4021-8344	19	5058-9057	41	9N-9150	106	GOLD-7	30
4021-8346	41	5061N-9082	35	9N-HS-65	43	GOLD-8	36
4030-8425	52	5061N-9083	24	9009-HS-65	43	GOLD-9	16
4030-8426	56	5064-41	111	920-BF	117	KD-302-40	44
4033-8434	40	5064-49	100	920-BFF	117	KD-302-41	25
4033-8435	53	5064-8425	53	920-MA	117	KD-302-42	69
4033-8436	40	5064-9106	55	920-MAF	117	KD-303-15	101
4033-8437	69	5065-41	110	920-PV	117	KD-303-17	25
4054-8595	41	5065-49	100	920-PVF	117	KD-303-18	44
4054-8597	69	5065-9127	73	928-BF	117	KD-303-20	69
4058-41	109	5065-9142	48	928-BFF	117	KD-309-01	98
4058-49	99	5065-9144	47	928-BFP	117	KD-309-02	108
4058-8673	73	5065-9146	49	928-MA	117	REI LUIZ-8668	29
4058-8696	60	5065-HS-257	67	928-MAF	117	REI LUIZ-8669	7
4058-8697	59	5066-13	42	928-PFP	117	SL01-100	113
4058-8968	60	5066-41	110	928-PV	117	SL01-209	113
4058-8969	59	5066-49	100	928-PVF	117	SL02-106	23
4058-8970	61	5066-9054	51	938-BF	116	SL02-148	45
4058-9025	73	5067-49	95	938-BFF	116	SL02-9165	23
4058-9026	73	5067-9151	65	938-MA	116	SL02-9166	45
4058-9054	52	5067-9152	17	938-MAF	116	SL07-108	24
4058-9104	99	5067-9153	37	938-PV	116	SL07-148	45
4058-9142	48	5105-1978	26	938-PVF	116	SL12-126	54
4058-9144	47	5105-1979	42	966-26-C	79	SL21-144	53
4058-9146	49	5105-41	106	968-41	108	SL21-145	54
4058-9150	109	5105-49	96	968-49	98	SL22-148	39
4062-01-41	109	5248-7655	81	98-41	108	SL22-205	23
4062-01-49	99	5248-7656	77	98-49	98	SL36-101	100
4062-8673	73	5248-TEKA	77	98-7656	77	SL36-126	54
4062-8679	71	53-8142	78	98-9054	52	SL36-220	69
4077-9167	75	53-8143	78	98-9104	98	SL36-9054	51
4077-9168	75	6034-1134	57	98-9142	48	SL58-194	54
4077-9169	75	6034-5159	26	98-9144	47	SL93N-278	11
4078-01-41	109	6034-8547	43	98-9146	49	VOLÚPIA	8
4078-01-49	99	6034-9028	71	98-9150	108		
4078-9027	73	6034-9041	79	98-TEKA	77		
5003N-01-41	121	6034-9142	48	997-41	109		
5003N-01-49	121	6034-9144	47	997-49	99		

Índice dinâmico

Dynamic Index / Índice Dinámico

	DOURADO Gold / Dorado	PRATA Silver / Plateado	METALIZADO Metallic / Metálico	LAMINADO Laminated / Laminado	AMADEIRADO Woody / Amaderado	RÚSTICO Rustic / Rústico	PROVENÇAL Provence / Provenzal	COLORIDO Colored / Colorido	PRETO Black / Negro	BRANCO White / Blanco	FILETES E PASSEPARTOUT Filet and passepartout / Filete y passepartout	CANALETAS E COMPLEMENTOS DE TELAS Floater / Molduras para Enmarcar Telas	CHASSIS Stretcher bar / Bastidor
10			•					•	•				
1034	•												
1109								•	•				
117		•											
1210	•	•	•		•		•	•	•				
122	•		•					•	•				
1220				•									
1428								•	•				
1448	•						•		•				
149	•												
1510	•	•		•	•			•	•				
1512				•									
180	•												
1907N										•			
2004												•	
2011						•						•	
2016	•	•	•		•		•	•	•				
2021				•									
2035	•	•						•	•	•			
2037	•	•											
2042		•											
2043	•	•											
2044	•	•											
2046	•												
2055	•	•											
2059	•	•											
2063	•	•											
2066	•	•											
2072	•	•											
2074N											•		
2098				•									
2118								•	•				
2151	•												
2233	•							•	•				
2266N	•												
227	•		•		•		•	•	•				

	DOURADO Gold / Dorado	PRATA Silver / Plateado	METALIZADO Metallic / Metálico	LAMINADO Laminated / Laminado	AMADEIRADO Woody / Amaderado	RÚSTICO Rustic / Rústico	PROVENÇAL Provence / Provenzal	COLORIDO Colored / Colorido	PRETO Black / Negro	BRANCO White / Blanco	FILETES E PASSEPARTOUT Filet and passepartout / Filete y passepartout	CANALETAS E COMPLEMENTOS DE TELAS Floater / Molduras para Enmarcar Telas	CHASSIS Stretch for / Bastidor
270N	•												
3002	•		•		•			•	•	•			
3015											•		
3023	•				•								
3027	•					•							
3028	•												
3033	•	•								•			
3034	•	•											
3036	•	•						•					
3043					•		•	•	•				
3046					•						•		
3047						•							
3055	•	•						•	•				
3057					•								
3060	•	•				•		•					
3066											•		
3067								•	•				
3068											•		
3069	•	•			•	•							
3070								•	•				
3071					•								
3073	•	•					•	•	•				
3074												•	
3075	•	•											
3076												•	
3079					•								
309		•				•							
329	•	•						•	•				
350	•	•						•	•				
354	•	•											
380	•	•			•	•							
3806											•		
381	•				•								
398								•	•				
40										•			
4013						•							

Índice dinâmico

Dynamic Index / Índice Dinámico

	DOURADO Gold / Dorado	PRATA Silver / Plateado	METALIZADO Metallic / Metálico	LAMINADO Laminated / Laminado	AMADEIRADO Woody / Amaderado	RÚSTICO Rustic / Rústico	PROVENÇAL Provence / Provenzal	COLORIDO Colored / Colorido	PRETO Black / Negro	BRANCO White / Blanco	FILETES E PASSEPARTOUT Filet and passepartout / Filete y passepartout	CANALETAS E COMPLEMENTOS DE TELAS Floater / Molduras para Enmarcar Telas	CHASSIS Stretching bar / Bastidor
4015			•					•	•				
4021	•	•											
4030			•										
4033		•	•		•								
4054		•			•								
4058			•	•	•			•	•				
4062				•	•			•	•				
4077						•							
4078				•				•	•				
5003N											•		
5028										•			
5032			•					•	•				
5033	•												
5039		•			•								
5040						•							
5044	•	•											
5045	•	•											
5048	•				•								
5050			•										
5054			•					•	•				
5058		•						•					
5061N	•	•											
5064			•					•	•				
5065			•		•			•	•				
5066		•	•					•	•				
5067	•	•			•			•					
5105	•	•						•	•				
5248						•	•						
53						•							
6034	•	•	•		•	•		•	•				
6059N	•							•					
663N								•					
720	•												
78	•	•						•	•				
8007					•			•	•				
8008					•			•	•				

	DOURADO Gold / Dorado	PRATA Silver / Prateado	METALIZADO Metallic / Metálico	LAMINADO Laminated / Laminado	AMADEIRADO Woody / Amaderado	RÚSTICO Rustic / Rústico	PROVENÇAL Provence / Provenzal	COLORIDO Colored / Colorido	PRETO Black / Negro	BRANCO White / Branco	FILETES E PASSEPARTOUT Filet and passepartout / Filete y passepartout	CANALETAS E COMPLEMENTOS DE TELAS Floater / Molduras para Emmancar Telas	CHASSIS Stretchers / Bastidor
81	•	•											
9N		•	•					•	•				
9009		•											
920											•		
928											•		
938											•		
966						•							
968								•	•				
98			•			•		•	•				
997				•	•		•	•	•				
998			•					•	•				
Chassi 20x38-CH												•	
Chassi 2x2												•	
Chassi 3x1,5 CH												•	
Chassi-20x33-CH												•	
Chassi-20x48-CH												•	
E246						•							
G7S	•	•											
GOLD-7		•											
GOLD-8		•											
GOLD-9	•												
KD-302	•	•			•								
KD-303	•	•			•			•					
KD-309								•	•				
REI LUIZ	•	•											
SL01										•			
SL02	•	•											
SL07	•	•											
SL12			•										
SL21			•										
SL22	•	•											
SL36			•		•			•					
SL58			•										
SL93	•												
Volúpia	•												

Tabela de equivalência

List of the equivalence / Listado de equivalencia

MOLDURAS QUE ESTAVAM NA LINHA 2017/2018 E PERMANECEM EM LINHA COM ALTERAÇÕES

Mouldings that were available in our stock program 2017/2018 and remain in line with changes
Molduras que estaban en línea stock 2017/2018 y se mantienen en línea con los cambios

LINHA/LINE/LÍNEA 2017/2018		LINHA/LINE/LÍNEA 2019/2020	
Moldura	Medida	Moldura	Medida
2017-1560	11x22x8mm	2016-1560	13x20x9mm
2017-CT4A	11x22x8mm	2016-CT4A	13x20x9mm
2017-GANO	11x22x8mm	2016-GANO	13x20x9mm
2017-HS-65	11x22x8mm	2016-HS-65	13x20x9mm
2018-1134	11x20x8mm	2016-1134	13x20x9mm
2018-1136	11x20x8mm	2016-1136	13x20x9mm
2018-23	11x20x8mm	2016-23	13x20x9mm
2018-24	11x20x8mm	2016-24	13x20x9mm
2018-26	11x20x8mm	2016-26	13x20x9mm
2018-27	11x20x8mm	2016-27	13x20x9mm
2018-33	11x20x8mm	2016-33	13x20x9mm
2018-34	11x20x8mm	2016-34	13x20x9mm
2018-47	11x20x8mm	2016-47	13x20x9mm
2018-59	11x20x8mm	2016-59	13x20x9mm
2018-8322	11x20x8mm	2016-8322	13x20x9mm
2018-GVF	11x20x8mm	2016-GVF	13x20x9mm
SL114-301	11x20x6mm	2016-301	13x20x9mm
SL114-302	11x20x6mm	2016-302	13x20x9mm
5031-8469	11x20x8mm	2016-8469	13x20x9mm
5031-8470	11x20x8mm	2016-8470	13x20x9mm
5031-8471	11x20x8mm	2016-8471	13x20x9mm
5047-8673	13x20x9mm	2016-8673	13x20x9mm
135-5159	14x38x10mm	6034-5159	14x38x9mm
135-8547	14x38x10mm	6034-8547	14x38x9mm
2096-1134	14x38x10mm	6034-1134	14x38x9mm
2096-GANO	14x38x10mm	6034-GANO	14x38x9mm
4058-01-41	14x38x33mm	4078-01-41	14x35x30mm
4058-01-49	14x38x33mm	4078-01-49	14x35x30mm
4058-9027	14x38x33mm	4078-9027	14x35x30mm
5003-9027	22x44x39mm	5003N-9027	20x44x39mm
5003-8673	22x44x39mm	5003N-8673	20x44x39mm
5003-01-41	22x44x39mm	5003N-01-41	20x44x39mm
5003-01-49	22x44x39mm	5003N-01-49	20x44x39mm
5003-9028	22x44x39mm	5003N-9028	20x44x39mm
5003-9029	22x44x39mm	5003N-9029	20x44x39mm
2074-01-41	21x38x25mm	2074N-01-41	20x35x25mm
2074-01-49	21x38x25mm	2074N-01-49	20x35x25mm
2074-8673	21x38x25mm	2074N-8673	20x35x25mm
2074-8674	21x38x25mm	2074N-8674	20x35x25mm
2074-9027	21x38x25mm	2074N-9027	20x35x25mm
2074-9111	21x38x25mm	2074N-9111	20x35x25mm
2266-1548	29x74x16mm	2266N-1548	28x71x15mm
270-237	27x110,5x15mm	270N-237	28x108x17mm
SL93-278	38x89x15mm	SL93N-278	34x95x12mm
6059-8257	11x34x7mm	6059N-8257	11x33x7mm
6059-8259	11x34x7mm	6059N-8259	11x33x7mm
5061-9082	28x34x8mm	5061N-9082	28x33x8mm
5061-9083	28x34x8mm	5061N-9083	28x33x8mm
1907-01-41	7x19mm	1907N-01-41	6x19mm
663-PRO	22x63x13mm	663N-PRO	20x63x11mm
9-9104	22x38x8mm	9N-9104	20x38x8mm
9-9150	22x38x8mm	9N-9150	20x38x8mm
9-HS-65	22x38x8mm	9N-HS-65	20x38x8mm

Você encontra nossos produtos aqui:

*Find our products here
Encuentre nuestros productos aquí*

Espaço para os materiais de lançamentos

New releases / Lanzamientos

 **Moldurarte**[®]



www.moldurarte.com.br | 0800 642 2122
comercial@moldurarte.com.br